

**Allom**

**Architectural Lighting**

The object is the object - Studio FPM 1973



God is in the Details - Mies Van de Rohe 1929

## Awards

Design awards, Italy, Germany, USA and UK

Product in Museum of Modern Art, New York, MOMA, since 1973



**MOMA**

## Logistics

Allom Architectural Lighting delivers all over Europe via London, Antwerp, Berlin, Milan, Paris, Warsaw, Zurich.

Gulf and Asia Pacific - Dubai, Doha, Mumbai, Seoul, Singapore, Sydney, and Tokyo.

USA - Baltimore, Cleveland, Houston, Long Beach.

### Digital Infrastructure

Revit, Cobuilder, Solidworks, Adobe Creative Suite, Sage 50, Office 365.

## Product Compliance

Guarantee - 10 years warranted and insured by Lloyd's of London

Heat transfer thermal dynamics convection cooling laminar flow

Allom Cool Head Technology™

**OPTIM•AL™**

385+ luminaires;

£5m product liability insurance for each major market;

a solid state company for electronics research and development.

Long product life, recyclable, biodegradable packaging Industrial, Retail, Residential.

TUV / CE/ Rohs / Recolight / UKCA ISO 9001 ISO 14001

## Timing is everything

- 1961** Peter Nelson, Britains foremost aircraft modeller, starts AL, designs and makes Series S.  
Prior to this he modelled 12 versions of the Constellation aeroplane working with Howard Hughes.
- 1967** Series A designed and made. 'More with less'.  
750watt Light Box for retail, and gallery lighting.
- 1972** AL is the first lighting business in Europe to give a 5 year guarantee.
- 1974** Manufacture in Japan, USA and Italy.  
'The Object is the object', the purpose of our work is to make better products  
and a better world.
- 1975** Cylinder Series UK and USA, 'The best for the most with the least'
- 1982** Series 20, mr16
- 1987** Series 30, B15d
- 1990** Series 900
- 1992** Allom picture lights
- 1995** Series 200, GU10
- 2004** Series 40, AR111, Allom Cool Head Technology™
- 2008** LED modules, Newton Series, patented UK, EU, USA, Brunel, Red Dot.
- 2017** Greenlight for vertical farming
- 2021** Medic-AL, Dept. for Health, Covid solution.
- 2022** Electric Vehicle charging point for kerbside,  
Skyraft patented UK, EU, USA & Skydisk.
- 2023** Energy saving patented projectors for track and ceiling plate.
- 2024** OPTIM-AL 10 years warranted and insured

## Philosophy

We work continuously for a better world with longer product life, 98% recycling and always following the maxim of R. Buckminster Fuller: more with less.

Wir arbeiten permanent an der verbesserung unserer produkte, um deren lebensdauer und 98% recyclebarkeit zu gewährleisten. Unser motto ist die maxime von R. Buckminster Fuller: more with less.

Nous travaillons continuellement pour un monde meilleur avec une durée de vie de produit plus longue, 98% recyclable et en suivant toujours la maxime de R. Buckminster Fuller: more with less.

Lavoriamo in continuazione per creare un mondo, con prodotti di lunga durata e riciclabili al 98%. Tuttocio sempre seguendo il motto di R. Buckminster Fuller: more with less.

Nosotros trabajamos continuamente para crear un mundo mejor, con productos más duraderos, reciclables en un 98% y siempre siguiendo el lema de R. Buckminster Fuller: more with less.

Nós trabalhamos continuamente para criar um mundo melhor, com produtos de longa duração, 98% reciclando e sempre seguindo o lema de R. Buckminster Fuller: more with less.

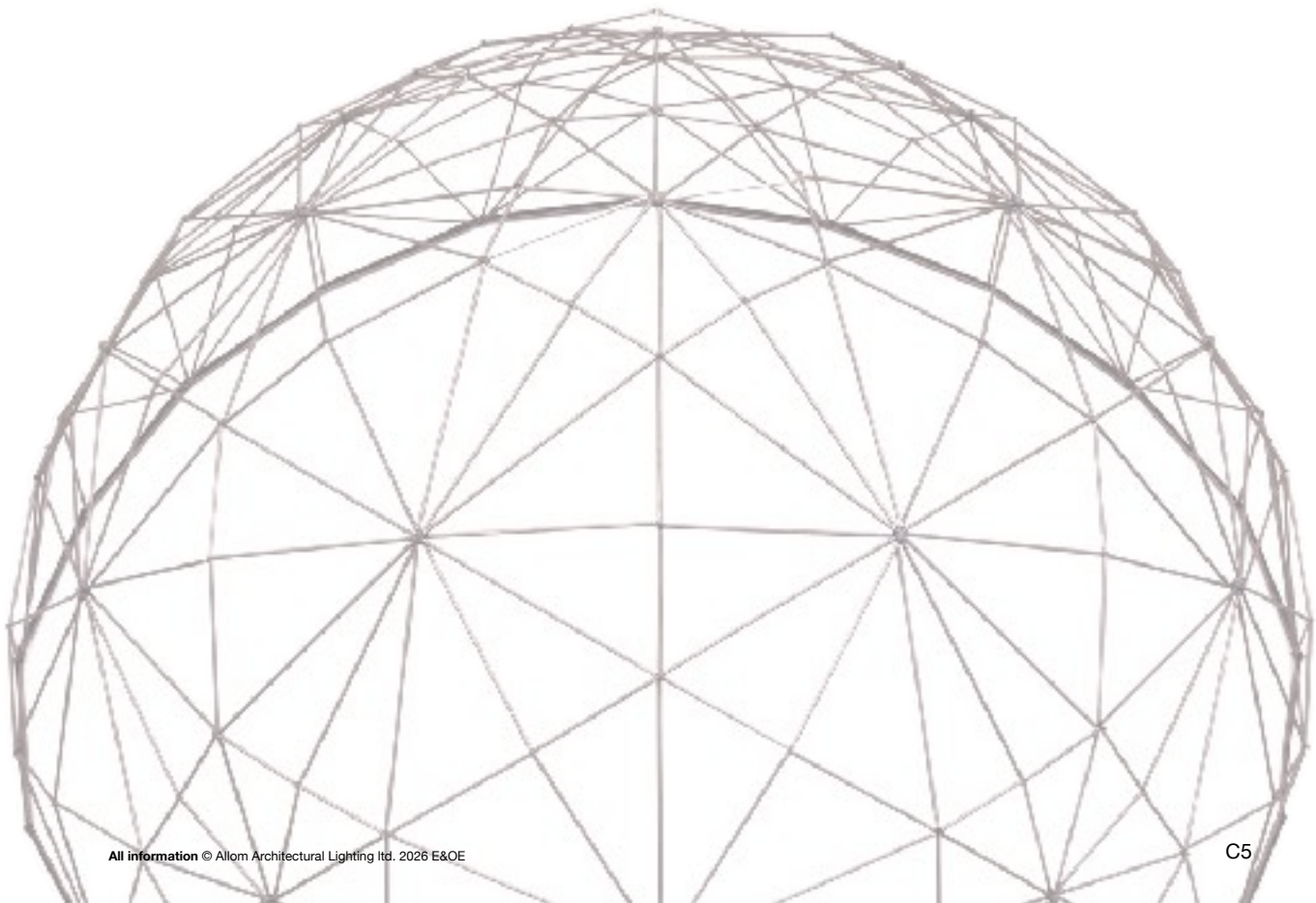

## Influences

"We do these things not because they are easy but because they are hard" -

President John F Kennedy

"God is in the details" - Mies van der Rohe

"One thing will be decisive the way we assert ourselves in the face of circumstance" - Mies van der Rohe

"We cross the river by feeling the stones" - Deng Xiaoping

"An engineer can be an artist, but an artist cannot be an engineer" -

Frank Malina, Paris 1966

"The object is the object. The purpose of our work is to make better products and a better world" - Studio FPM, Milan 1972

"More with less" - R. Buckminster Fuller

"The best for the most with the least" - Ray Eames

"Design is not about decoration; it is about creating a space that enhances life" –

Charlotte Perriand

Pythagoras, Fibonacci, Galileo, Newton, Faraday, Swan, Tatlin, Malevitch, Rodchenko, Lissitzky, Aalto, van der Rohe, Takis, Malina, Gabo, Spencer, Castelli, Magistretti, Castiglione, Straub, Boothby, Kape, Mari.



## Products - All with 10 year guarantee

# OPTIM●AL

<b>GU10</b>	1.9 watt 398 lumen non dim 36 degree 50,000 hours Energy label A
<b>INTEGRATED</b>	5 watt 600 lumens dim 3/4/6K switchable, CRI90, IP65 fire rated 90mins 38 degree Energy label E
<b>CIRCULAR</b>	Bulkhead with only 68mm projection 12 watts, 1440 lumens, 3/4/6.5K switchable, IP65 on-off, micro-sensor, EM, 3 year 2x batteries, 3 hours Li-ion. Energy Label E  Bulkhead with 78mm projection to take a 20mm conduit tube 12 watts, 1440 lumens, 3/4/6.5K switchable, IP65 on-off, micro-sensor, EM, 3 year 2x batteries, 3 hours Li-ion for 20% output. Energy Label E
<b>SKYDISK</b>	Circular Highbay, 298mm dia 145 watt 29725 lumen IP65, 60,000 hours service life, 3 metre chainset and 3 metre power cable 4/5/6.6K switchable, Beam 55 or 85 degrees  EM version as above but with 3 year, 3 hour Li-Ion battery for 10%. Energy label B
<b>SKYRAFT</b>	Linear Highbay, Made in Aluminium. Energy saving, COOL BRIDGE, IP65.  Optional EM version at 20% performance for 3 hours with 3 Li-ION batteries with 3 year battery life. 3.5 metre chains and 3.5 metre power feeds as required 10 year guarantee, 90,000 Service life 4/6K switchable Energy label D
<b>DREADNOUGHT</b>	Bulkhead Series, Diecast Stainless steel body, 20/30/50 watts, 3000, 5000, 8000 lumen 3/4/5/6K switchable, M/S, Fire rated 90 minutes  EM version available 20% for 3 hours and 3 year life Energy label C and E
<b>PROJECTOR</b>	Fixed Beam Track and ceiling plate. The overall wattage for major retail stores is 15watts. 2400lm, 160lm/watt Energy label C
<b>NEWTON</b>	A series of 17 task lights at 8 watts and 1280 lumens, the best in class, with a universal dimmable driver at 97v-277v Energy label C
<b>EVCP</b>	Rapid Electrical Vehicle Charging Point



# OPTIM•AL



Guarantee

Energy

Product Code

OPGU10A3983N36UKEU

## OPTIM•AL GU10

**Longlife/Glass**

### Certifications

UKCA CE RoHS SELV

Recolight

ISO 9001 ISO 14001

Trademark

**OPTIM•AL**

Energy Label **A**

### Specifications

**Guarantee** 10 years warranted and insured by Lloyd's of London

**Lumens** 398

**Watts** 1.9

**Lumens/Watt** 210

**CCT** 3000k

**CRI** 80

**Beam angle** 36 degrees

**Types** Non Dim

**Dimensions** Dia. 50mm, Height 55.5mm

**Driver** Constant current

**Service life** 50,000 Hours rating

# OPTIM•AL



Guarantee



Energy

Product Code

OPINTE600346D900365FR90UKEU

## INTEGRATED

**Fire rated  
integrated downlight**

### Certifications

CE RoHS SELV,  
UKCA, Recolight,  
VDE, TUV  
ISO 9001, ISO 14001,  
SEDEX & SMETA  
IP65

Trademark

**OPTIM•AL**

Energy Label **E**

### Specifications

**Guarantee** 10 years warranted and insured by Lloyd's of London

**Fire Rated** 90 minutes

**Material** Bezel RAL 9003 white

**Watts** 5

**Lumens/watt** 600

**Watts/Voltage** 175w, 97-277v

**CCT** 3/4/6k switchable

**CRI** 80

**Beam angle** 38 degrees

**Types** Dimmable recommended with Varilight Pro

**Dimensions** Dia. 84mm, cut out 68mm dia

**Service life** 60,000 Hours rating



# OPTIM•AL



Guarantee

Energy

## Product Code

OPCIRCE14403465N900354UKEU  
OPCIRCE14403465N901054UKEU  
OPCIRCE14403465N900354MSUKEU  
OPCIRCE14403465N901054MSUKEU  
OPCIRCE14403465N90039054EMUKEU  
OPCIRCE14403465N90109054EMUKEU  
OPCIRCE14403465N90039054EMMSUKEU  
OPCIRCE14403465N90109054EMMSUKEU

## CIRCULAR BULKHEAD

**Fire Retardant  
Polycarbonate**

### Uses

General lighting,  
ceiling or wall, stairs  
and communal areas

### Certifications

TUV CE Rohs  
Recolight  
IP65  
Trademark  
**OPTIM•AL**  
Design copyright  
Studio FPM  
Energy Label **E**

## Specifications

**Guarantee** 10 years warranted and insured by Lloyd's of London

**Fire Rated** 90 minutes

**Material** RAL 9003 White or RAL 9010 Warm White

**Lumens** 1440

**Watts** 12 Watts, Non DIM

**Lumens/watt** 120 lumens at 12 watts

**CCT** 3/4/6.5k switchable

**CRI** 80

**Driver** PF95

**Dimensions** 315mm dia, 68mm projection

**Service life** 50000 hours /10 years, 2x Li-Ion batteries at 3.2V  
and 150mAh, total 6.4V and 300mAh, 3 years and 3 hours



# OPTIM•AL



Guarantee



Energy

Product Code

OPCIRCCONE14403465N900365UKEU  
OPCIRCCONE14403465N900365MSUKEU  
OPCIRCCONE14403465N900365EMUKEU  
OPCIRCCONE14403465N900365EMMSUKEU

## CIRCULAR BULKHEAD

**Fire Retardant  
Polycarbonate**

### Uses

General lighting,  
ceiling or wall, stairs  
and communal areas

### Certifications

TUV CE Rohs  
Recolight  
IP65

Trademark

**OPTIM•AL**

Design copyright

Studio FPM

Energy Label **E**

### Specifications

**Guarantee** 10 years warranted and insured by Lloyd's of London

**Fire Rated** 90 minutes

**Material** RAL 9003 White or RAL 9010 Warm White

**Lumens** 1440

**Watts** 12 Watts, Non DIM

**Lumens/watt** 120 lumens at 12 watts

**CCT** 3/4/6.5k switchable

**CRI** 80

**Driver** PF95

**Dimensions** 315mm dia, 78mm projection to take a 20mm conduit tube

**Service life** 50000 hours /10 years, 2x Li-Ion batteries at 3.2V and 150mAh, total 6.4V and 300mAh, 3 years and 3 hours



# OPTIM•AL



**Guarantee.**

**Energy**

**Product Code**

- OPDISKB29725456.565UKEU
- OPDISKB29725456.565EMUKEU
- OPDISKB20500456.565UKEU
- OPDISKB20500456.565EMUKEU
- OPDISKB15375456.565UKEU
- OPDISKB15375456.565EMUKEU

## SkyDisc

**Top Spec Circular Highbay Series with 3 lumen outputs**

### Uses

Industrial,  
Warehouse  
Rail

### Certifications

TUV CE RoHS, SELV  
Recolight UKCA  
IP65

Trademark

### OPTIM•AL

Design copyright  
Studio FPM  
Energy Label **B**

### Specifications

**Guarantee** 10 years warranted and insured by Lloyd's of London

**Material** High pressure die cast Aluminum body, RAL 9004

**Lumens** 29725, 20500, 15375, Lumileds 2835

**Watts** 75, 100, 145

**CCT** 4/5/6.5k Switchable,

**CRI** 80

**Beam** 55 or 85 degrees

**Driver** 1x Lifud, 200watt for 145, 100 or 75 watts

**Dimensions** 298mm dia, weight 4 or 6 kg

**Types** On-off, MS, 3 metre power feeds and 3 metre chainsets

EM version with 10% output on 3 or 2 Li-Ion batteries, 3 hours and 3 years life, smart controls on application, Bluetooth, Dali, ZigBee

**Service life** 60,000 hours



**Guarantee**

**Energy**

**Product Code**

OPRAFTC27700456DMSUKEU  
OPRAFTC27700456DMSEMUKEU  
OPRAFTC20775456DMSUKEU  
OPRAFTC20775456DMSEMUKEU  
OPRAFTC13850456DMSUKEU  
OPRAFTC13850456DMSEMUKEU

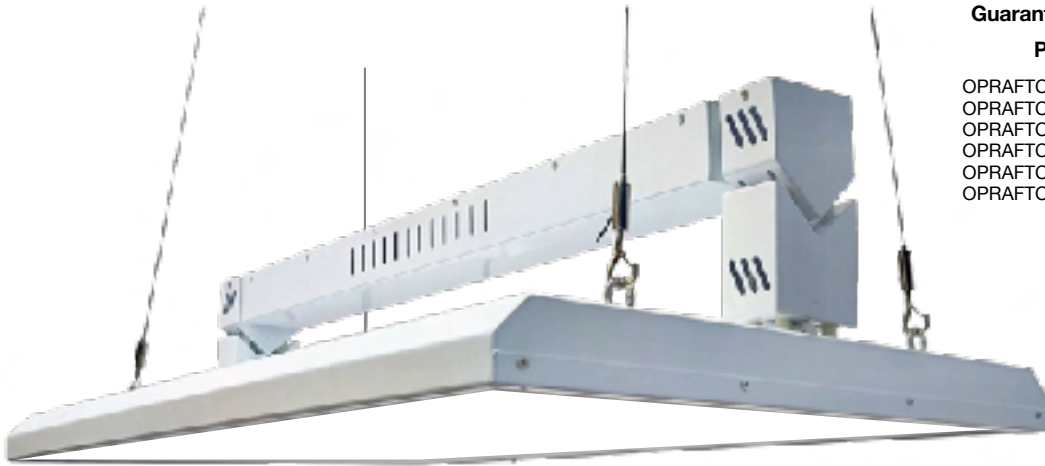

## SkyRaft

**Top specification  
Highbay with  
COOL BRIDGE®**

### Uses

Data Centres,  
Battery factories  
Distribution centres  
Industrial Depots

### Certifications

VDE, TUV, UKCA, CE,  
Rohs, SELV,  
Recolight, UL, CUL  
IP54, IK08  
Patented  
UK, EU, USA  
Trademark

### OPTIM•AL

Design copyright  
Studio FPM  
Energy Label **D**

## Specifications

Flicker free; 10 years, warranted and insured Lloyd's of London

**COOL BRIDGE®** Temperature 99-5F (37-5C)

**Material** Aluminium/Steel RAL 9003 white

**Lumens/watt** 135, for 23625 total lumens under run for Long Life

**Watts/Voltage** 175w, 97-277v

**CCT** 4/6K Switchable

**CRI** 80

**Beam angle** 120 degrees

**Types** On-off, MS, dim and/or EM Li-Ion 3 x 3 hour or 2 x 3 hour at 20%

Batteries 3 year life, **Casambi®** controlled, PIR, and dim

**EM** version 10 x 21700 Li-Ion top spec long life batteries

**Drivers** 1 x isolated Inventronic at 200w

**Dimensions** 800 x 400 x 180mm

**Weight** 6-8kg, or 14-96 lbs and EM at 8-8kg or 19-36lbs

**Service life** 90,000 hours L70

Energy Saving  
**SkyRaft**

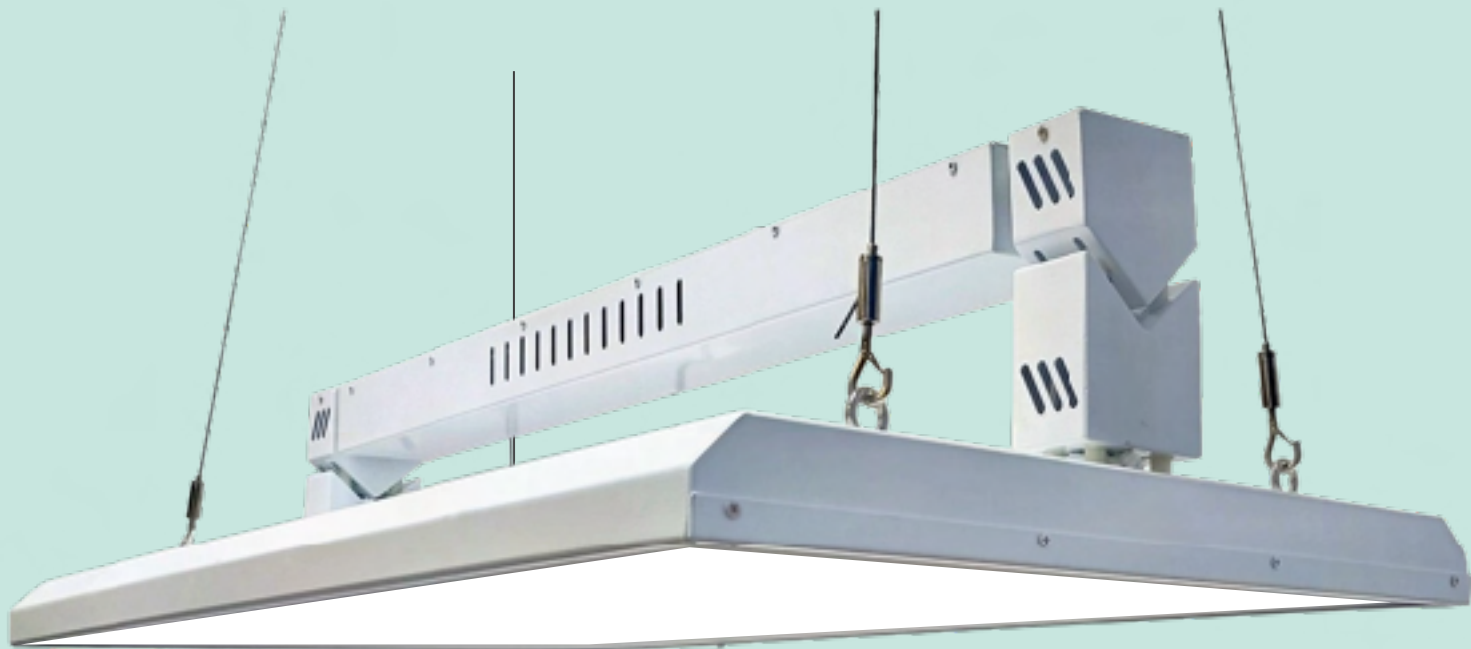

**Data Centres**  
**Battery Factories**  
**Distribution Centres**  
**Industrial Depots**  
**Patented UK, EU, USA**

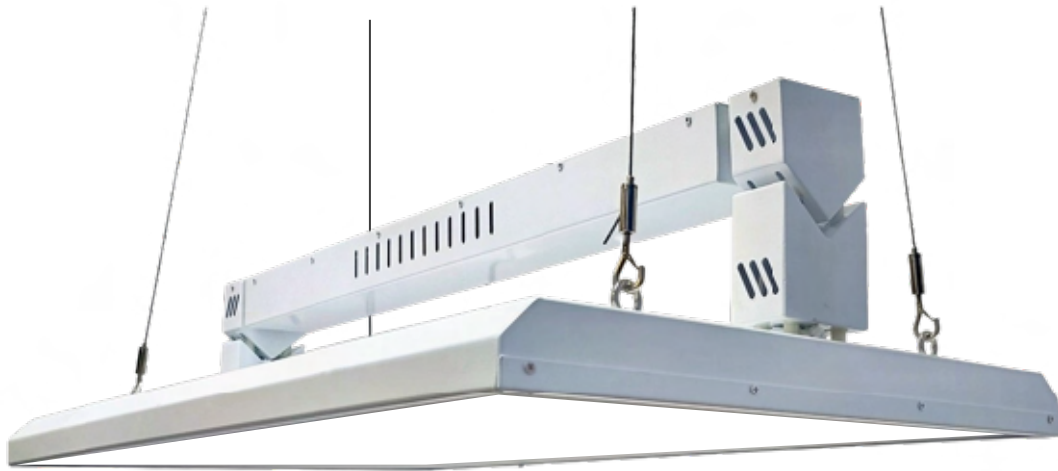

10 year guarantee

Certificated & insured by Lloyds of London

TUV, VDE, CE, Nemko, UKCA, UL, CUL

23625 Lumens

175 Watts

4000 or 6000K

90,000 hour rating

Beam Angle 120°

800 x 400 x 180mm

31 x 15.75 x 70.8 inches

Standard version 6.30 kilos

Standard version 14 lbs

Emergency version 8.30 kilos

Emergency version 18.25 lbs

Energy Label D

Allom Cool Head  
Technology™  
patented in UK,  
France, Germany  
and USA.

Bridge temperature is  
37-5C, allowing us to  
guarantee and insure  
the driver for ten years  
and the Li-ion batteries  
in the emergency  
version for three years.



**LUMINAIRE PHOTOMETRIC TEST REPORT**

Test:U:219.36V I:0.7778A P:166.71W PF:0.9771 Freq:50.00Hz Lamp Flux:22214.1x1 lm		
NAME: LSLH-175W	TYPE:	WEIGHT:
SPEC.:	DIM.:	SERIAL No.:LSLH-170W
MFR.: LSLH	SUR.:	Shielding Angle:

DATA OF LAMP		PHOTOMETRIC DATA				Eff: 133.25 lm/W
MODEL	LSLH-175W	I <sub>max</sub> (cd)	6699	S/MH (C0/180)	1.27	
NOMINAL POWER (W)	175	LOR (%)	100.0	S/MH (C90/270)	1.30	
RATED VOLTAGE (V)	220	TOTAL FLUX (lm)	22214	η UP, DN (C0-180)	0.7, 47.6	
NOMINAL FLUX (lm)	22214.1	CIE CLASS	DIRECT	η UP, DN (C180-360)	0.7, 51.1	
LAMPS INSIDE	1	η up (%)	1.4	CIBSE SHR NOM	1.25	
TEST VOLTAGE (V)	220	η down (%)	98.6	CIBSE SHR MAX	1.35	

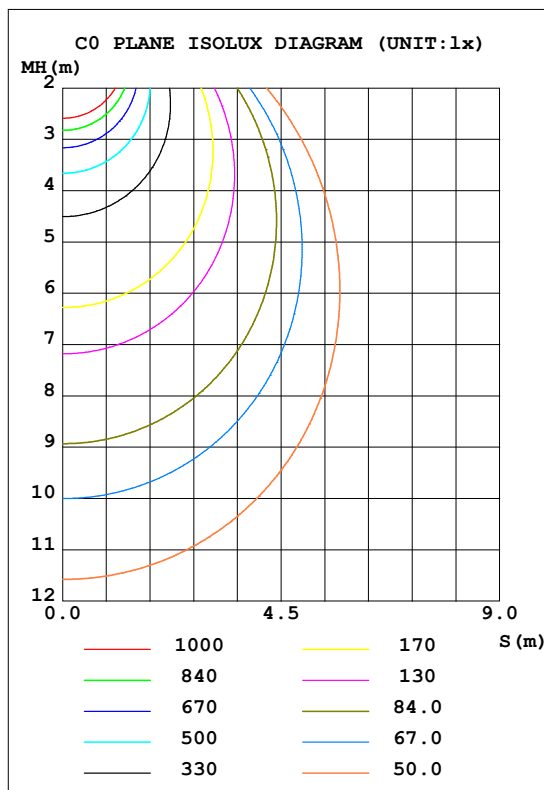
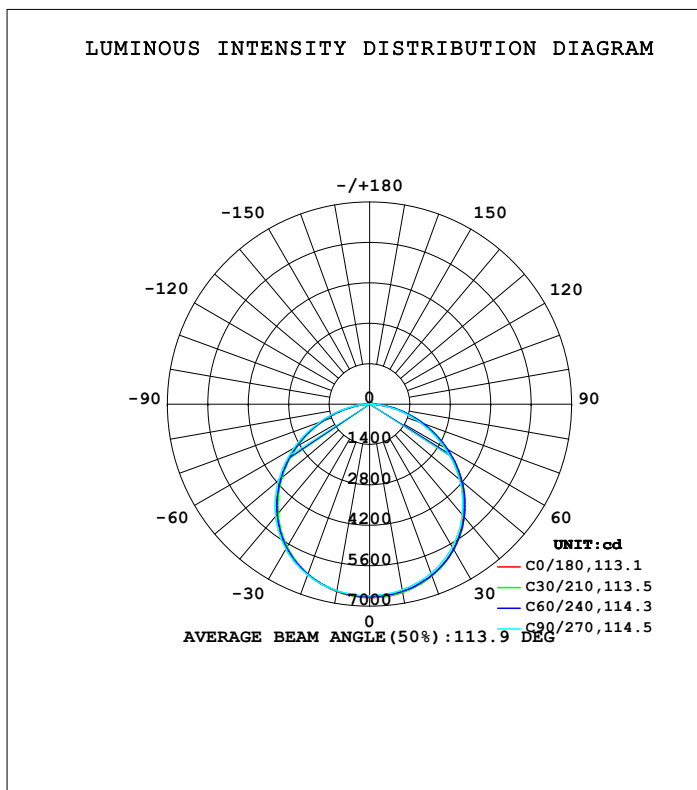

C Range: 0 - 360DEG  
C Interval: 30.0DEG  
Test Speed: HIGH  
Temperature: 25.3DEG  
Operators: H  
Test Date: 2025-07-24

γ Range: 0 - 180DEG  
γ Interval: 1.0DEG  
Test System: EVERFINE GO-2000B\_V1 SYSTEM V2.0.404.7  
Humidity: 65.0%  
Test Distance: 4.430m [K=1.0000]  
Remarks:

**ZONAL FLUX DIAGRAM**

ZONAL FLUX DIAGRAM:

$\gamma$	C0	C45	C90	C135	C180	C225	C270	C315	$\gamma$	$\Phi$ zone	$\Phi$ total	%lum,lamp
10	6613	6592	6525	6393	6586	6573	6561	6622	0- 10	630.1	630.1	3.2,3.2
20	6321	6312	6228	5981	6265	6265	6294	6445	10- 20	1816	2447	12.4,12.4
30	5803	5818	5721	5352	5720	5731	5804	6052	20- 30	2780	5227	26.5,26.5
40	5054	5098	4992	4514	4950	4965	5073	5420	30- 40	3379	8605	43.7,43.7
50	4108	4175	4063	3515	3989	3995	4123	4559	40- 50	3513	12118	61.5,61.5
60	3027	3107	2990	2421	2906	2890	3020	3518	50- 60	3160	15278	77.5,77.5
70	1898	1977	1861	1328	1788	1746	1858	2378	60- 70	2394	17673	89.6,89.6
80	821.2	893.5	791.0	347.1	733.7	676.3	763.1	1248	70- 80	1382	19055	96.7,96.7
90	19.09	32.21	19.20	21.87	20.17	20.48	19.97	247.7	80- 90	389.2	19444	98.6,98.6
100	24.51	23.69	24.47	28.43	26.37	26.19	24.90	22.66	90-100	31.69	19476	98.8,98.8
110	33.12	31.66	32.44	36.75	34.92	34.15	32.47	30.10	100-110	30.52	19506	98.9,98.9
120	43.49	41.33	41.60	46.73	44.57	43.65	41.06	39.15	110-120	37.79	19544	99.1,99.1
130	51.11	48.47	47.88	53.81	51.19	49.63	46.23	45.12	120-130	41.34	19585	99.3,99.3
140	56.57	53.93	52.67	57.41	56.37	54.00	50.85	50.44	130-140	39.98	19625	99.6,99.6
150	61.16	59.60	57.63	60.07	61.05	56.90	55.79	56.02	140-150	35.22	19661	99.7,99.7
160	66.64	65.97	62.44	65.66	66.80	61.91	61.29	62.44	150-160	28.19	19689	99.9,99.9
170	71.43	69.42	65.20	68.72	73.80	67.81	65.23	67.64	160-170	18.83	19708	100,100
180	66.11	62.76	59.81	61.79	66.15	62.75	59.90	61.79	170-180	6.442	19714	100,100
DEG	LUMINOUS INTENSITY:cd									UNIT:lm		

C Range: 0 - 360DEG  
C Interval: 30.0DEG  
Test Speed: HIGH  
Temperature:25.3DEG  
Operators:H  
Test Date:2025-07-24

$\gamma$  Range: 0 - 180DEG  
 $\gamma$  Interval: 1.0DEG  
Test System:EVERFINE GO-2000B\_V1 SYSTEM V2.0.404.7  
Humidity:65.0%  
Test Distance:4.430m [K=1.0000]  
Remarks:

**LUMINANCE LIMITATION CURVES**

Test:U:219.36V I:0.7778A P:166.71W PF:0.9771 Freq:50.00Hz Lamp Flux:22214.1x1 lm		
NAME: LSLH-175W	TYPE:	WEIGHT:
SPEC.:	DIM.:	SERIAL No.:LSLH-170W
MFR.: LSLH	SUR.:	Shielding Angle:

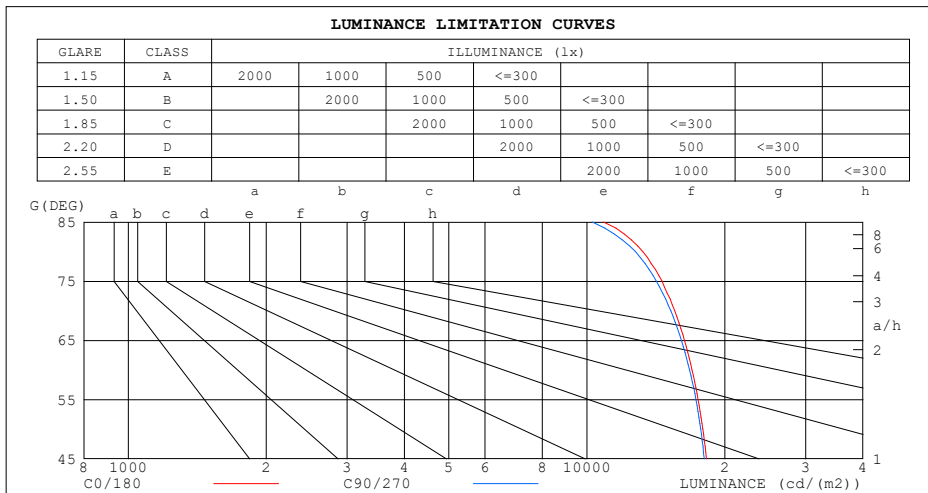

LUMINANCE cd/(m2)		
G (DEG)	C0/180	C90/270
85	10870	10279
80	13250	12763
75	14590	14186
70	15546	15246
65	16325	16082
60	16964	16754
55	17489	17292
50	17906	17710
45	18243	18031

C Range: 0 - 360DEG  
C Interval: 30.0DEG  
Test Speed: HIGH  
Temperature:25.3DEG  
Operators:H  
Test Date:2025-07-24

γ Range: 0 - 180DEG  
γ Interval: 1.0DEG  
Test System:EVERFINE GO-2000B\_V1 SYSTEM V2.0.404.7  
Humidity:65.0%  
Test Distance:4.430m [K=1.0000]  
Remarks:

**CU AND LUMINAIRE BUDGETARY ESTIMATE DIAGRAM**

Test:U:219.36V I:0.7778A P:166.71W PF:0.9771 Freq:50.00Hz Lamp Flux:22214.1x1 lm		
NAME: LSLH-175W	TYPE:	WEIGHT:
SPEC.:	DIM.:	SERIAL No.:LSLH-170W
MFR.: LSLH	SUR.:	Shielding Angle:

$\rho_{cc}$	80%			70%			50%			30%			10%			0
$\rho_w$	50%	30%	10%	50%	30%	10%	50%	30%	10%	50%	30%	10%	50%	30%	10%	0
$\rho_{fc}$	20%			20%			20%			20%			20%			0
RCR	RCR:Room Cavity Ratio						Coefficients of Utilization(CU)									
0.0	1.19	1.19	1.19	1.16	1.16	1.16	1.10	1.10	1.10	1.05	1.05	1.05	1.01	1.01	1.01	.99
1.0	1.03	.99	.95	1.01	.97	.94	.97	.93	.90	.92	.90	.87	.89	.86	.85	.82
2.0	.90	.83	.77	.88	.82	.76	.84	.79	.74	.81	.76	.72	.78	.74	.71	.68
3.0	.79	.71	.64	.77	.70	.63	.74	.68	.62	.71	.66	.61	.68	.64	.60	.57
4.0	.70	.61	.54	.68	.60	.54	.66	.59	.53	.63	.57	.52	.61	.56	.51	.49
5.0	.62	.53	.47	.61	.53	.46	.59	.51	.46	.57	.50	.45	.55	.49	.44	.42
6.0	.56	.47	.41	.55	.47	.40	.53	.46	.40	.51	.45	.39	.50	.44	.39	.37
7.0	.51	.42	.36	.50	.42	.36	.48	.41	.35	.47	.40	.35	.45	.39	.35	.33
8.0	.46	.38	.32	.46	.37	.32	.44	.37	.31	.43	.36	.31	.41	.35	.31	.29
9.0	.42	.34	.29	.42	.34	.29	.41	.33	.28	.39	.33	.28	.38	.32	.28	.26
10.0	.39	.31	.26	.39	.31	.26	.38	.30	.26	.36	.30	.25	.35	.30	.25	.24

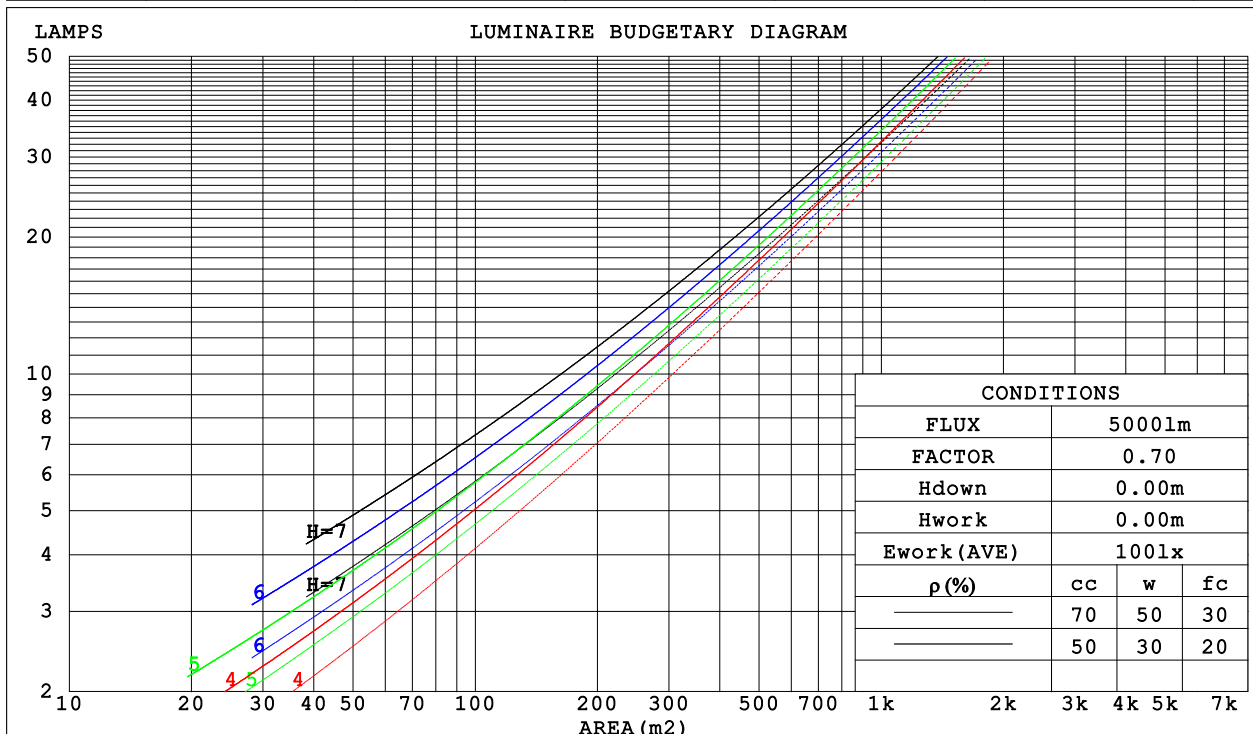

C Range: 0 - 360DEG  
 C Interval: 30.0DEG  
 Test Speed: HIGH  
 Temperature:25.3DEG  
 Operators:H  
 Test Date:2025-07-24

$\gamma$  Range: 0 - 180DEG  
 $\gamma$  Interval: 1.0DEG  
 Test System:EVERFINE GO-2000B\_V1 SYSTEM V2.0.404.7  
 Humidity:65.0%  
 Test Distance:4.430m [K=1.0000]  
 Remarks:

**WEC AND CCEC**

Test:U:219.36V I:0.7778A P:166.71W PF:0.9771 Freq:50.00Hz Lamp Flux:22214.1x1 lm		
NAME: LSLH-175W	TYPE:	WEIGHT:
SPEC.:	DIM.:	SERIAL No.:LSLH-170W
MFR.: LSLH	SUR.:	Shielding Angle:

ρcc	80%			70%			50%			30%			10%			0
ρw	50%	30%	10%	50%	30%	10%	50%	30%	10%	50%	30%	10%	50%	30%	10%	0
ρfc	20%			20%			20%			20%			20%			0
RCR	RCR:Room Cavity Ratio						Wall Exitance Coefficients (WEC)									
0.0																
1.0	.311	.177	.056	.304	.173	.055	.290	.166	.053	.277	.160	.051	.265	.153	.049	
2.0	.292	.160	.049	.286	.157	.048	.273	.152	.047	.262	.147	.046	.251	.142	.045	
3.0	.270	.144	.043	.265	.142	.043	.254	.137	.042	.243	.133	.041	.234	.129	.040	
4.0	.249	.130	.038	.244	.128	.038	.234	.124	.037	.225	.121	.037	.217	.118	.036	
5.0	.231	.117	.034	.226	.116	.034	.217	.113	.033	.209	.110	.033	.201	.108	.032	
6.0	.214	.107	.031	.210	.106	.030	.202	.103	.030	.195	.101	.030	.188	.099	.029	
7.0	.199	.098	.028	.195	.097	.028	.188	.095	.027	.182	.093	.027	.176	.091	.027	
8.0	.186	.091	.026	.182	.090	.025	.176	.088	.025	.170	.086	.025	.165	.085	.025	
9.0	.174	.084	.024	.171	.083	.023	.165	.082	.023	.160	.080	.023	.155	.079	.023	
10.0	.164	.078	.022	.161	.078	.022	.156	.076	.022	.151	.075	.021	.146	.074	.021	

ρcc	80%			70%			50%			30%			10%			0
ρw	50%	30%	10%	50%	30%	10%	50%	30%	10%	50%	30%	10%	50%	30%	10%	0
ρfc	20%			20%			20%			20%			20%			0
RCR	RCR:Room Cavity Ratio						Ceiling Cavity Exitance Coefficients (CCEC)									
0.0	.201	.201	.201	.172	.172	.172	.117	.117	.117	.067	.067	.067	.022	.022	.022	
1.0	.191	.167	.145	.163	.143	.125	.112	.098	.086	.064	.057	.050	.021	.018	.016	
2.0	.183	.142	.109	.157	.123	.094	.107	.085	.065	.062	.049	.038	.020	.016	.012	
3.0	.175	.125	.085	.150	.108	.074	.103	.075	.052	.060	.044	.030	.019	.014	.010	
4.0	.168	.112	.069	.144	.097	.060	.099	.067	.042	.057	.039	.025	.018	.013	.008	
5.0	.160	.101	.058	.138	.088	.050	.095	.061	.036	.055	.036	.021	.018	.012	.007	
6.0	.153	.093	.050	.132	.081	.043	.091	.056	.031	.053	.033	.018	.017	.011	.006	
7.0	.146	.086	.044	.126	.075	.038	.087	.052	.027	.050	.031	.016	.016	.010	.005	
8.0	.140	.080	.039	.120	.070	.034	.083	.049	.024	.048	.029	.015	.016	.009	.005	
9.0	.134	.075	.036	.115	.065	.031	.080	.046	.022	.046	.027	.013	.015	.009	.004	
10.0	.128	.071	.033	.110	.062	.029	.077	.043	.021	.045	.026	.012	.014	.008	.004	

C Range: 0 - 360DEG  
C Interval: 30.0DEG  
Test Speed: HIGH  
Temperature:25.3DEG  
Operators:H  
Test Date:2025-07-24

γ Range: 0 - 180DEG  
γ Interval: 1.0DEG  
Test System:EVERFINE GO-2000B\_V1 SYSTEM V2.0.404.7  
Humidity:65.0%  
Test Distance:4.430m [K=1.0000]  
Remarks:

**UGR(Unified Glare Rating) Table**

Test:U:219.36V I:0.7778A P:166.71W PF:0.9771 Freq:50.00Hz Lamp Flux:22214.1x1 lm										
NAME: LSLH-175W					TYPE:			WEIGHT:		
SPEC.:					DIM.:			SERIAL No.:LSLH-170W		
MFR.: LSLH					SUR.:			Shielding Angle:		
ceiling/cavity	0.7	0.7	0.5	0.5	0.3	0.7	0.7	0.5	0.5	0.3
walls	0.5	0.3	0.5	0.3	0.3	0.5	0.3	0.5	0.3	0.3
working plane	0.2	0.2	0.2	0.2	0.2	0.2	0.2	0.2	0.2	0.2
Room dimensions	Viewed crosswise					Viewed endwise				
x = 2H y = 2H	22.9	24.4	23.2	24.6	24.8	22.9	24.4	23.1	24.6	24.8
3H	24.4	25.8	24.7	26.0	26.3	24.4	25.8	24.7	26.0	26.3
4H	25.0	26.3	25.4	26.6	26.9	25.0	26.3	25.3	26.6	26.9
6H	25.5	26.7	25.8	27.0	27.3	25.4	26.6	25.8	26.9	27.3
8H	25.6	26.8	26.0	27.1	27.4	25.5	26.7	25.9	27.0	27.4
12H	25.7	26.8	26.1	27.2	27.5	25.6	26.8	26.0	27.1	27.4
4H 2H	23.5	24.8	23.8	25.1	25.4	23.5	24.8	23.8	25.1	25.4
3H	25.2	26.4	25.6	26.7	27.0	25.2	26.4	25.6	26.7	27.0
4H	26.0	27.0	26.4	27.4	27.7	26.0	27.0	26.4	27.4	27.7
6H	26.6	27.5	27.0	27.9	28.3	26.5	27.5	26.9	27.8	28.2
8H	26.8	27.6	27.2	28.0	28.5	26.7	27.6	27.2	28.0	28.4
12H	26.9	27.7	27.3	28.1	28.5	26.8	27.6	27.3	28.0	28.5
8H 4H	26.3	27.2	26.7	27.6	28.0	26.3	27.1	26.7	27.5	27.9
6H	27.0	27.8	27.5	28.2	28.7	27.0	27.7	27.5	28.2	28.6
8H	27.3	28.0	27.8	28.4	28.9	27.3	27.9	27.8	28.4	28.9
12H	27.5	28.1	28.0	28.6	29.1	27.5	28.1	28.0	28.5	29.0
12H 4H	26.3	27.1	26.8	27.5	28.0	26.3	27.1	26.7	27.5	27.9
6H	27.1	27.8	27.6	28.2	28.7	27.1	27.7	27.6	28.2	28.7
8H	27.5	28.0	28.0	28.5	29.0	27.4	28.0	27.9	28.4	29.0
Variations with the observer position at spacings:										
S = 1.0H	+ 0.1 / - 0.2					+ 0.2 / - 0.2				
1.5H	+ 0.2 / - 0.3					+ 0.2 / - 0.3				
2.0H	+ 0.1 / - 0.3					+ 0.1 / - 0.4				

CIE Pub.117, 19714 lm Total Lamp Luminous Flux Corrected (8log(F/F0) = 10.4)

C Range: 0 - 360DEG	γ Range: 0 - 180DEG
C Interval: 30.0DEG	γ Interval: 1.0DEG
Test Speed: HIGH	Test System:EVERFINE GO-2000B_V1 SYSTEM V2.0.404.7
Temperature:25.3DEG	Humidity:65.0%
Operators:H	Test Distance:4.430m [K=1.0000]
Test Date:2025-07-24	Remarks:

**UTILIZATION FACTORS TABLE**

Test:U:219.36V I:0.7778A P:166.71W PF:0.9771 Freq:50.00Hz Lamp Flux:22214.1x1 lm		
NAME: LSLH-175W	TYPE:	WEIGHT:
SPEC.:	DIM.:	SERIAL No.:LSLH-170W
MFR.: LSLH	SUR.:	Shielding Angle:

REFLECTANCE										
Ceiling	0.8	0.8	0.8	0.7	0.7	0.7	0.5	0.5	0.5	0
Walls	0.7	0.5	0.3	0.7	0.5	0.3	0.7	0.5	0.3	0
Working plane	0.2	0.2	0.2	0.2	0.2	0.2	0.2	0.2	0.2	0
ROOM INDEX	UTILIZATION FACTORS (PERCENT) $k(RI) \times RCR = 5$									
k = 0.60	57	45	38	56	45	38	55	44	38	31
0.80	67	55	48	66	55	48	64	54	47	40
1.00	75	64	57	74	64	57	72	65	56	49
1.25	82	72	65	81	71	64	78	70	63	56
1.50	87	78	70	86	77	70	83	75	69	61
2.00	94	86	79	92	84	78	89	82	77	69
2.50	98	90	84	96	89	83	92	86	81	73
3.00	102	95	89	99	93	88	95	90	86	77
4.00	106	100	95	103	98	94	99	95	91	82
5.00	108	103	99	106	101	97	101	97	94	85
ROOM INDEX	UF(total)									Direct
According to DIN EN 13032-2 2004			Suspended				SHRNOM = 1.25			

C Range: 0 - 360DEG  
C Interval: 30.0DEG  
Test Speed: HIGH  
Temperature:25.3DEG  
Operators:H  
Test Date:2025-07-24

$\gamma$  Range: 0 - 180DEG  
 $\gamma$  Interval: 1.0DEG  
Test System:EVERFINE GO-2000B\_V1 SYSTEM V2.0.404.7  
Humidity:65.0%  
Test Distance:4.430m [K=1.0000]  
Remarks:

**ISOCANDELA DIAGRAM**

Test:U:219.36V I:0.7778A P:166.71W PF:0.9771 Freq:50.00Hz Lamp Flux:22214.1x1 lm		
NAME: LSLH-175W	TYPE:	WEIGHT:
SPEC.:	DIM.:	SERIAL No.:LSLH-170W
MFR.: LSLH	SUR.:	Shielding Angle:

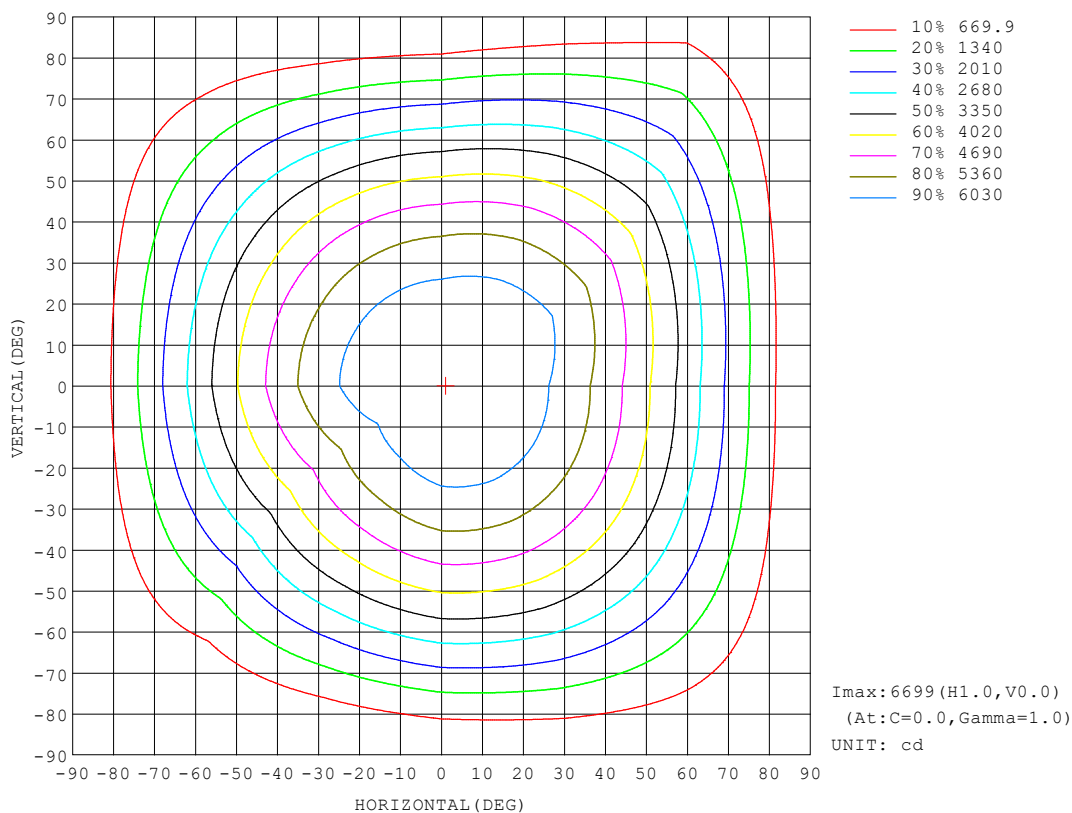

C Range: 0 - 360DEG  
 C Interval: 30.0DEG  
 Test Speed: HIGH  
 Temperature:25.3DEG  
 Operators:H  
 Test Date:2025-07-24

γ Range: 0 - 180DEG  
 γ Interval: 1.0DEG  
 Test System:EVERFINE GO-2000B\_V1 SYSTEM V2.0.404.7  
 Humidity:65.0%  
 Test Distance:4.430m [K=1.0000]  
 Remarks:

**AAI Figure**

Test:U:219.36V I:0.7778A P:166.71W PF:0.9771 Freq:50.00Hz Lamp Flux:22214.1x1 lm		
NAME: LSLH-175W	TYPE:	WEIGHT:
SPEC.:	DIM.:	SERIAL No.:LSLH-170W
MFR.: LSLH	SUR.:	Shielding Angle:

Flux out:14394 lm

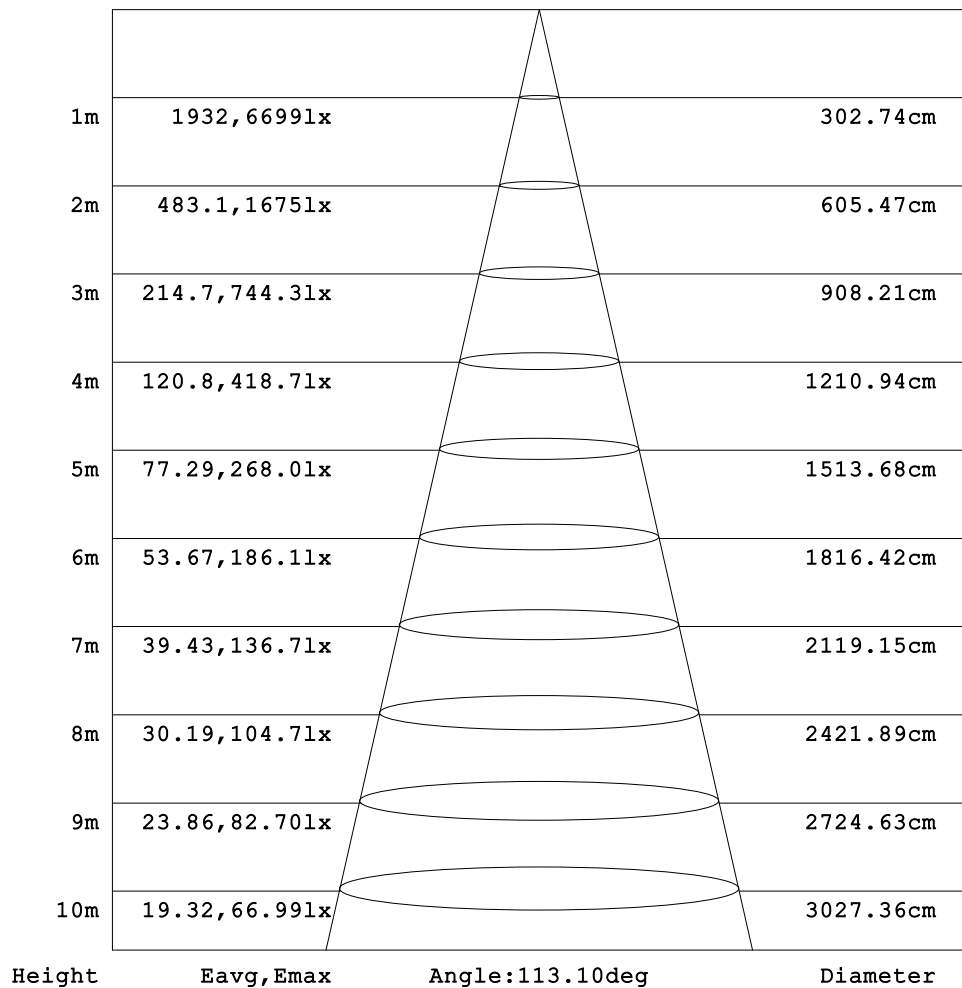

Note:The Curves indicate the illuminated area and the average illumination when the luminaire is at different distance.

C Range: 0 - 360DEG	γ Range: 0 - 180DEG
C Interval: 30.0DEG	γ Interval: 1.0DEG
Test Speed: HIGH	Test System:EVERFINE GO-2000B_V1 SYSTEM V2.0.404.7
Temperature:25.3DEG	Humidity:65.0%
Operators:H	Test Distance:4.430m [K=1.0000]
Test Date:2025-07-24	Remarks:

**ISOLUX DIAGRAM**

Test:U:219.36V I:0.7778A P:166.71W PF:0.9771 Freq:50.00Hz Lamp Flux:22214.1x1 lm		
NAME: LSLH-175W	TYPE:	WEIGHT:
SPEC.:	DIM.:	SERIAL No.:LSLH-170W
MFR.: LSLH	SUR.:	Shielding Angle:

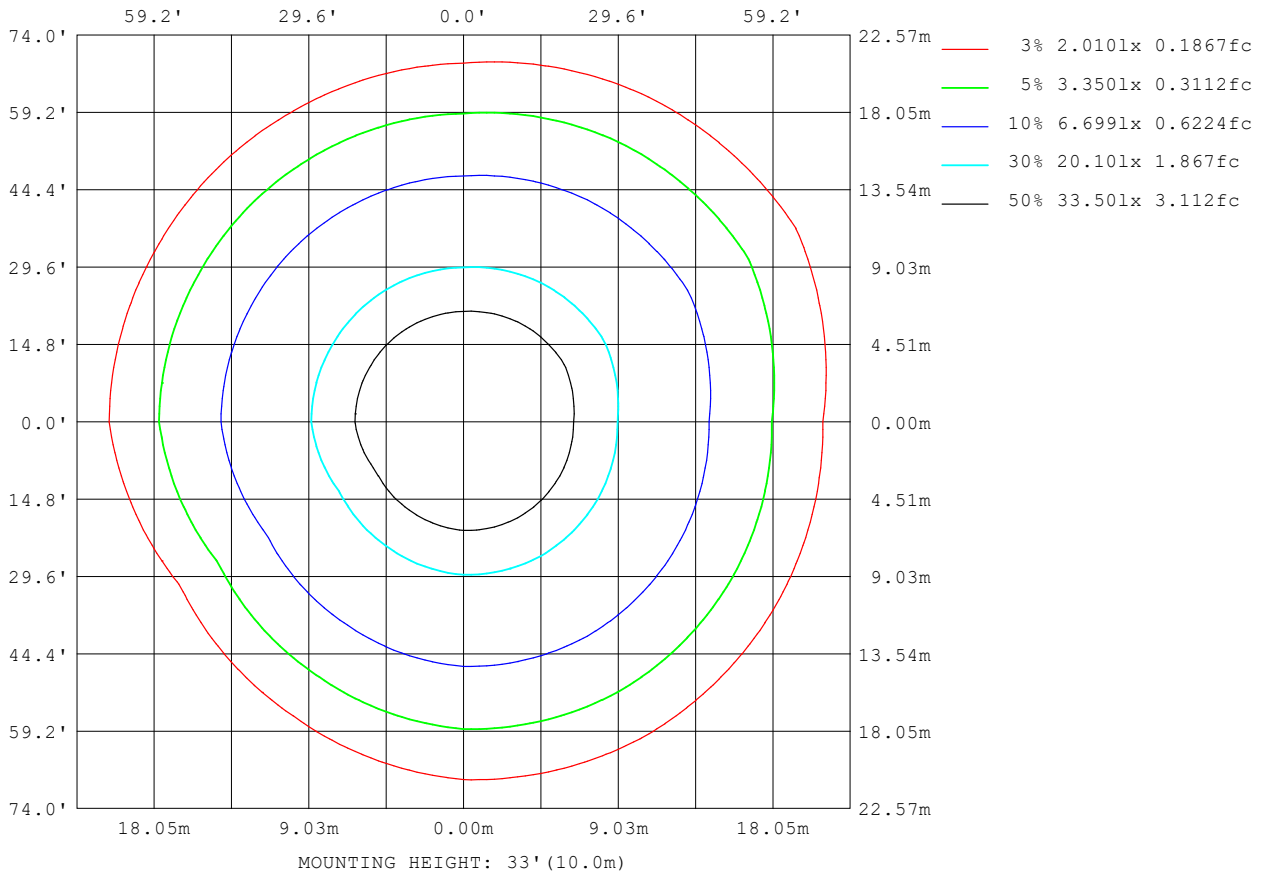

C Range: 0 - 360DEG  
C Interval: 30.0DEG  
Test Speed: HIGH  
Temperature:25.3DEG  
Operators:H  
Test Date:2025-07-24

γ Range: 0 - 180DEG  
γ Interval: 1.0DEG  
Test System:EVERFINE GO-2000B\_V1 SYSTEM V2.0.404.7  
Humidity:65.0%  
Test Distance:4.430m [K=1.0000]  
Remarks:

**LED Avg.L Report**

Test:U:219.36V I:0.7778A P:166.71W PF:0.9771 Freq:50.00Hz Lamp Flux:22214.1x1 lm		
NAME: LSLH-175W	TYPE:	WEIGHT:
SPEC.:	DIM.:	SERIAL No.:LSLH-170W
MFR.: LSLH	SUR.:	Shielding Angle:

AvgL	cd/m2
L_0~180 (65) av	15938
L_0~180 (75) av	14042
L_0~180 (85) av	9656
L_90~270 (65) av	16125
L_90~270 (75) av	14101
L_90~270 (85) av	9674
L_45 (65) av	16047
L_45 (75) av	14193
L_45 (85) av	11256

Standard: GB/T 29293-2012

C Range: 0 - 360DEG  
 C Interval: 30.0DEG  
 Test Speed: HIGH  
 Temperature:25.3DEG  
 Operators:H  
 Test Date:2025-07-24

γ Range: 0 - 180DEG  
 γ Interval: 1.0DEG  
 Test System:EVERFINE GO-2000B\_V1 SYSTEM V2.0.404.7  
 Humidity:65.0%  
 Test Distance:4.430m [K=1.0000]  
 Remarks:

**Planar Illuminance Curve**

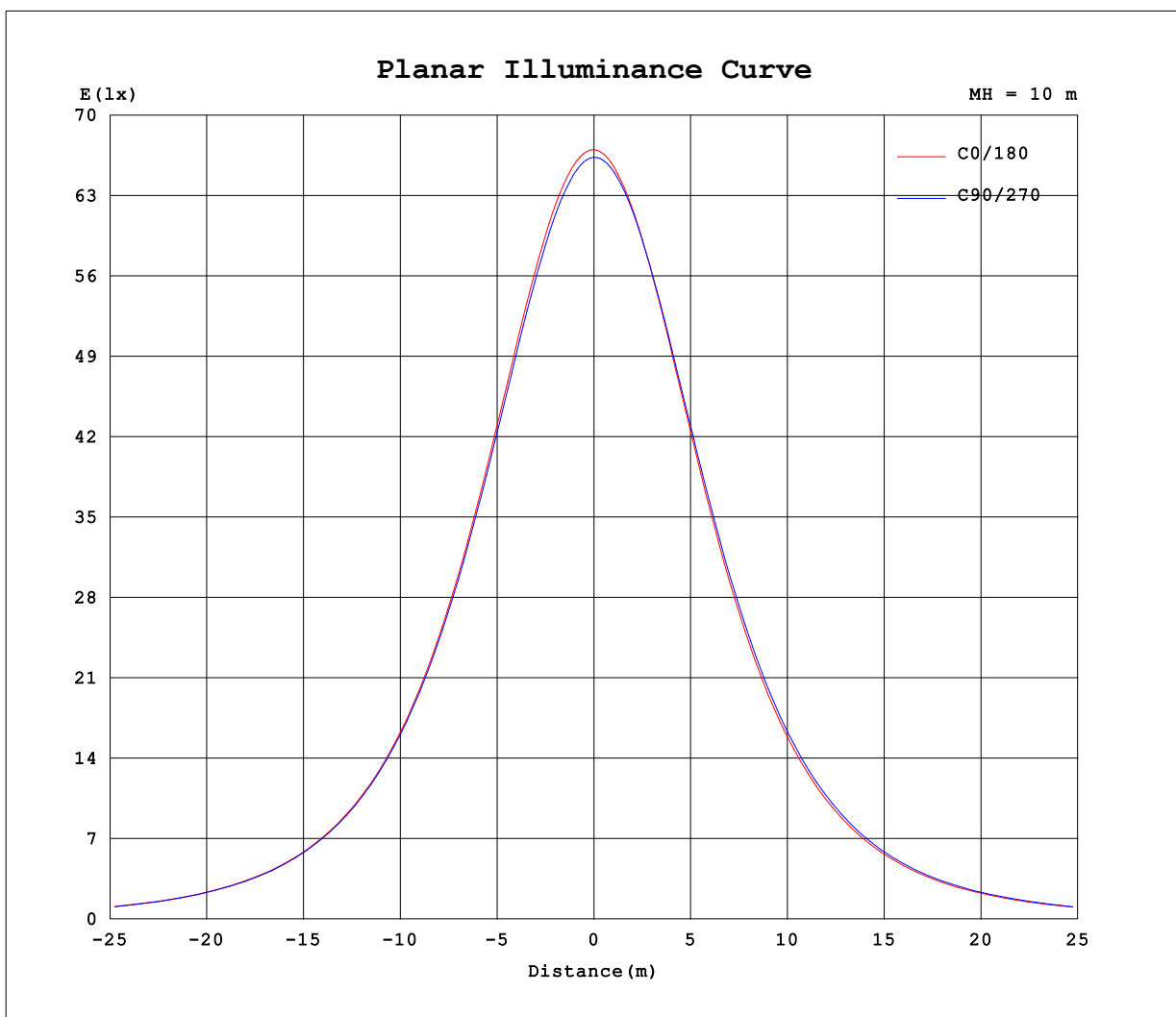

C Range: 0 - 360DEG  
 C Interval: 30.0DEG  
 Test Speed: HIGH  
 Temperature: 25.3DEG  
 Operators: H  
 Test Date: 2025-07-24

$\gamma$  Range: 0 - 180DEG  
 $\gamma$  Interval: 1.0DEG  
 Test System: EVERFINE GO-2000B\_V1 SYSTEM V2.0.404.7  
 Humidity: 65.0%  
 Test Distance: 4.430m [K=1.0000]  
 Remarks:

**LUMINOUS DISTRIBUTION INTENSITY DATA**

Test:U:219.36V I:0.7778A P:166.71W PF:0.9771 Freq:50.00Hz Lamp Flux:22214.1x1 lm		
NAME: LSLH-175W	TYPE:	WEIGHT:
SPEC.:	DIM.:	SERIAL No.:LSLH-170W
MFR.: LSLH	SUR.:	Shielding Angle:

Table--1

UNIT: cd

C (DEG) \ γ (DEG)	0	30	60	90	120	150	180	210	240	270	300	330							
0	6699	6689	6666	6633	6602	6604	6699	6689	6666	6633	6602	6604							
5	6681	6672	6645	6601	6534	6511	6667	6658	6641	6620	6624	6648							
10	6613	6606	6578	6525	6418	6368	6586	6577	6569	6561	6599	6644							
15	6494	6491	6465	6401	6254	6173	6452	6445	6446	6454	6526	6590							
20	6321	6324	6301	6228	6038	5924	6265	6259	6271	6294	6404	6487							
25	6090	6103	6084	6002	5768	5619	6022	6016	6040	6079	6227	6329							
30	5803	5824	5813	5721	5444	5260	5720	5714	5748	5804	5990	6114							
35	5455	5487	5483	5384	5064	4850	5362	5354	5397	5468	5693	5839							
40	5054	5097	5100	4992	4636	4393	4950	4939	4992	5073	5335	5505							
45	4604	4655	4665	4551	4165	3899	4489	4474	4529	4622	4918	5112							
50	4108	4168	4182	4063	3654	3375	3989	3968	4021	4123	4450	4668							
55	3580	3646	3664	3540	3119	2830	3459	3430	3478	3586	3937	4177							
60	3027	3096	3117	2990	2565	2276	2906	2870	2910	3020	3388	3648							
65	2462	2534	2552	2426	2007	1727	2346	2300	2333	2439	2816	3091							
70	1898	1969	1985	1861	1460	1197	1788	1734	1757	1858	2235	2520							
75	1348	1416	1430	1310	938	694	1246	1188	1202	1295	1661	1948							
80	821	888	899	791	457	238	734	673	680	763	1108	1388							
85	338	400	413	320	66.9	19.8	263	205	207	282	592	853							
90	19.1	18.6	45.8	19.2	21.3	22.4	20.2	20.8	20.2	20.0	133	362							
95	21.2	20.8	20.7	21.4	24.2	25.8	22.8	23.5	22.5	22.0	20.9	20.4							
100	24.5	23.9	23.5	24.5	27.5	29.4	26.4	26.9	25.5	24.9	23.2	22.1							
105	28.3	27.5	26.9	28.1	31.1	33.0	30.3	30.6	29.0	28.4	26.2	25.4							
110	33.1	32.0	31.3	32.4	35.8	37.7	34.9	35.1	33.2	32.5	30.4	29.8							
115	38.6	37.3	36.4	37.5	41.3	43.3	39.9	40.1	38.0	36.9	35.1	34.5							
120	43.5	41.8	40.9	41.6	45.4	48.1	44.6	44.8	42.5	41.1	39.5	38.8							
125	47.7	45.7	44.8	44.9	48.9	52.6	48.0	48.3	45.3	43.8	42.8	42.0							
130	51.1	49.1	47.8	47.9	51.7	56.0	51.2	51.6	47.7	46.2	45.5	44.8							
135	53.9	52.2	50.3	50.3	53.9	58.0	54.1	54.4	49.9	48.6	47.8	47.5							
140	56.6	54.9	52.9	52.7	56.0	58.9	56.4	56.0	52.0	50.9	50.4	50.5							
145	58.6	57.5	55.8	55.0	58.1	60.2	58.5	56.1	54.3	53.2	53.2	53.3							
150	61.2	60.4	58.8	57.6	60.6	59.6	61.1	57.3	56.5	55.8	55.9	56.1							
155	63.8	63.7	62.0	60.5	62.8	61.3	63.7	57.7	59.0	58.7	59.0	59.2							
160	66.6	67.3	64.6	62.4	64.9	66.5	66.8	62.2	61.6	61.3	62.1	62.8							
165	69.2	70.3	66.5	64.0	66.5	68.7	70.4	67.2	64.2	63.4	64.7	66.4							
170	71.4	71.7	67.2	65.2	67.3	70.2	73.8	69.4	66.2	65.2	66.2	69.1							
175	70.0	68.8	64.6	63.2	64.4	67.8	71.9	68.9	65.3	64.3	65.0	68.1							
180	66.1	64.6	61.0	59.8	60.3	63.3	66.1	64.5	61.0	59.9	60.3	63.3							

C Range: 0 - 360DEG  
C Interval: 30.0DEG  
Test Speed: HIGH  
Temperature:25.3DEG  
Operators:H  
Test Date:2025-07-24

γ Range: 0 - 180DEG  
γ Interval: 1.0DEG  
Test System:EVERFINE GO-2000B\_V1 SYSTEM V2.0.404.7  
Humidity:65.0%  
Test Distance:4.430m [K=1.0000]  
Remarks:

**LUMINAIRE PHOTOMETRIC TEST REPORT**

Test:U:219.47V I:0.1673A P:21.605W PF:0.5883 Freq:50.00Hz Lamp Flux:2757.01x1 lm		
NAME: LSLH-10%	TYPE:LSLH-10%	WEIGHT:
SPEC.:	DIM.:	SERIAL No.:LSLH-10%
MFR.: LSLH	SUR.:	Shielding Angle:

DATA OF LAMP		PHOTOMETRIC DATA				Eff: 127.61 lm/W
MODEL	LSLH-10%	I <sub>max</sub> (cd)	730.0	S/MH (C0/180)		1.23
NOMINAL POWER (W)	17	LOR (%)	100.0	S/MH (C90/270)		1.29
RATED VOLTAGE (V)	220	TOTAL FLUX (lm)	2757	η UP, DN (C0-180)		0.7, 48.6
NOMINAL FLUX (lm)	2757.01	CIE CLASS	DIRECT	η UP, DN (C180-360)		0.8, 49.9
LAMPS INSIDE	1	η up (%)	1.6	CIBSE SHR NOM		1.25
TEST VOLTAGE (V)	220	η down (%)	98.4	CIBSE SHR MAX		1.35

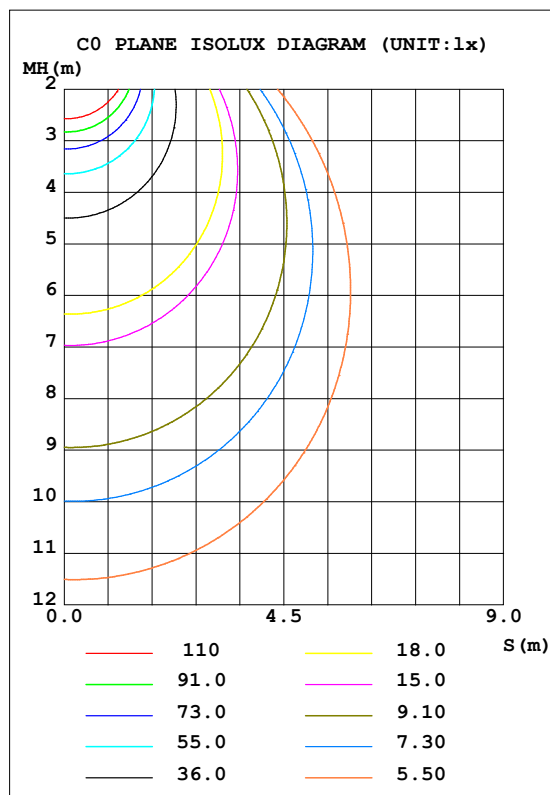
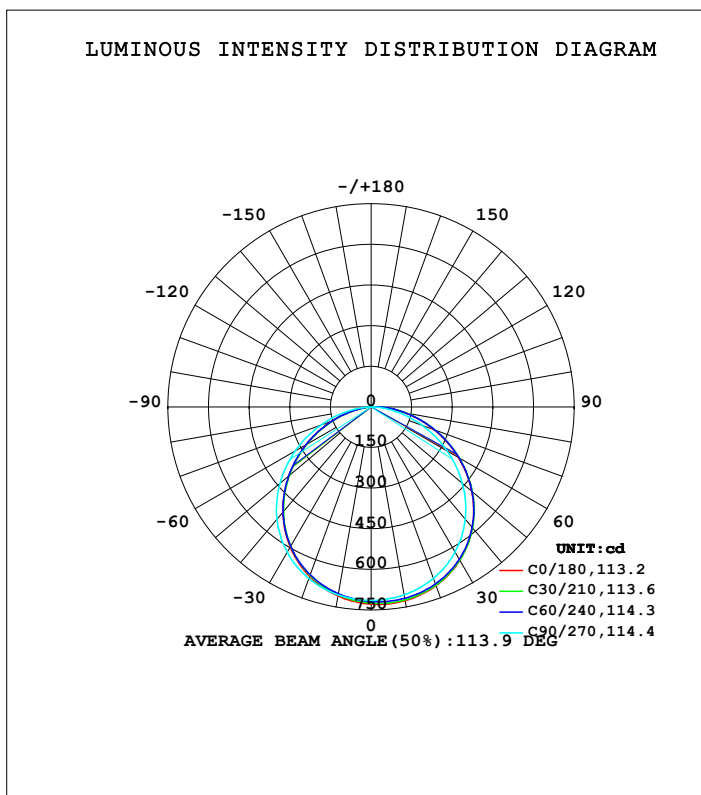

C Range: 0 - 360DEG  
C Interval: 30.0DEG  
Test Speed: HIGH  
Temperature: 25.3DEG  
Operators: C  
Test Date: 2026-01-29

γ Range: 0 - 180DEG  
γ Interval: 1.0DEG  
Test System: EVERFINE GO-2000B\_V1 SYSTEM V2.0.404.7  
Humidity: 65.0%  
Test Distance: 4.430m [K=1.0000]  
Remarks:

**ZONAL FLUX DIAGRAM**

ZONAL FLUX DIAGRAM:

$\gamma$	C0	C45	C90	C135	C180	C225	C270	C315	$\gamma$	$\Phi$ zone	$\Phi$ total	%lum,lamp
10	726.1	720.1	704.2	683.7	708.4	702.0	704.3	719.2	0- 10	68.06	68.06	3.17,3.17
20	702.0	697.7	673.4	632.4	665.4	660.3	673.8	705.4	10- 20	196.1	264.2	12.3,12.3
30	654.2	652.2	619.3	557.6	597.6	594.4	619.8	669.2	20- 30	299.9	564.0	26.3,26.3
40	581.1	581.7	540.8	461.1	506.2	504.7	541.1	608.2	30- 40	364.5	928.5	43.3,43.3
50	484.7	487.3	440.2	348.6	396.2	395.5	439.7	522.1	40- 50	379.2	1308	61,61
60	371.0	374.5	323.8	228.9	276.0	274.8	322.2	414.8	50- 60	341.7	1649	76.9,76.9
70	248.3	252.1	202.0	112.4	155.3	152.8	197.9	293.8	60- 70	260.0	1909	89,89
80	127.6	131.5	86.13	15.81	44.88	41.88	80.34	170.0	70- 80	151.6	2061	96.1,96.1
90	20.77	24.73	2.271	2.679	2.397	2.476	2.320	55.93	80- 90	50.77	2112	98.4,98.4
100	2.524	2.559	2.872	3.436	3.282	3.306	3.000	2.569	90-100	6.604	2118	98.8,98.8
110	3.419	3.391	3.727	4.317	4.142	4.142	3.796	3.262	100-110	3.547	2122	98.9,98.9
120	4.463	4.385	4.666	5.323	5.067	5.073	4.642	4.142	110-120	4.214	2126	99.1,99.1
130	5.337	5.229	5.395	6.084	5.871	5.837	5.327	4.924	120-130	4.602	2131	99.3,99.3
140	6.008	5.896	5.976	6.487	6.361	6.280	5.846	5.512	130-140	4.480	2135	99.5,99.5
150	6.544	6.536	6.539	6.785	6.875	6.491	6.387	6.139	140-150	3.942	2139	99.7,99.7
160	7.188	7.232	7.041	7.376	7.539	7.159	6.977	6.859	150-160	3.155	2142	99.9,99.9
170	7.736	7.643	7.305	7.691	8.218	7.717	7.346	7.447	160-170	2.104	2144	100,100
180	7.408	7.078	6.745	6.934	7.425	7.081	6.733	6.941	170-180	0.7141	2145	100,100
DEG	LUMINOUS INTENSITY:cd									UNIT:lm		

C Range: 0 - 360DEG  
 C Interval: 30.0DEG  
 Test Speed: HIGH  
 Temperature:25.3DEG  
 Operators:C  
 Test Date:2026-01-29

$\gamma$  Range: 0 - 180DEG  
 $\gamma$  Interval: 1.0DEG  
 Test System:EVERFINE GO-2000B\_V1 SYSTEM V2.0.404.7  
 Humidity:65.0%  
 Test Distance:4.430m [K=1.0000]  
 Remarks:

**LUMINANCE LIMITATION CURVES**

Test:U:219.47V I:0.1673A P:21.605W PF:0.5883 Freq:50.00Hz Lamp Flux:2757.01x1 lm		
NAME: LSLH-10%	TYPE:LSLH-10%	WEIGHT:
SPEC.:	DIM.:	SERIAL No.:LSLH-10%
MFR.: LSLH	SUR.:	Shielding Angle:

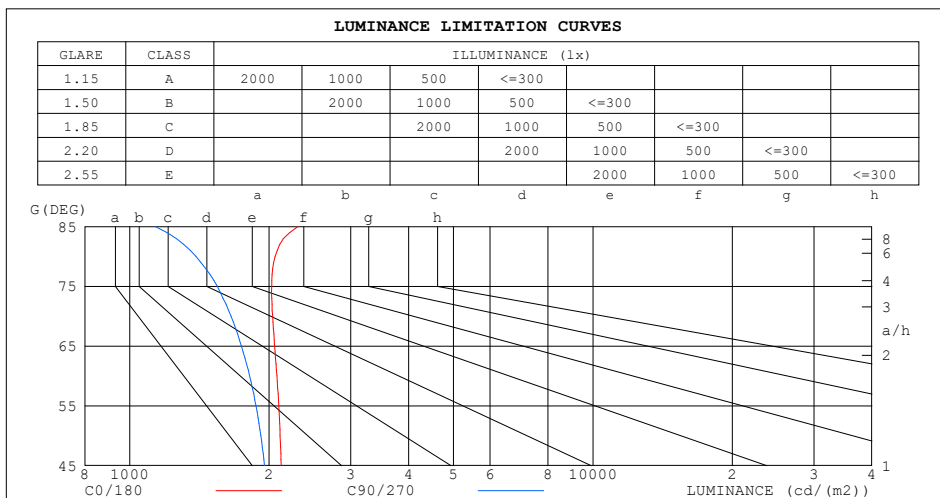

C Range: 0 - 360DEG  
C Interval: 30.0DEG  
Test Speed: HIGH  
Temperature:25.3DEG  
Operators:C  
Test Date:2026-01-29

γ Range: 0 - 180DEG  
γ Interval: 1.0DEG  
Test System:EVERFINE GO-2000B\_V1 SYSTEM V2.0.404.7  
Humidity:65.0%  
Test Distance:4.430m [K=1.0000]  
Remarks:

**CU AND LUMINAIRE BUDGETARY ESTIMATE DIAGRAM**

Test:U:219.47V I:0.1673A P:21.605W PF:0.5883 Freq:50.00Hz Lamp Flux:2757.01x1 lm		
NAME: LSLH-10%	TYPE:LSLH-10%	WEIGHT:
SPEC.:	DIM.:	SERIAL No.:LSLH-10%
MFR.: LSLH	SUR.:	Shielding Angle:

$\rho_{cc}$	80%			70%			50%			30%			10%			0
$\rho_w$	50%	30%	10%	50%	30%	10%	50%	30%	10%	50%	30%	10%	50%	30%	10%	0
$\rho_{fc}$	20%			20%			20%			20%			20%			0
RCR	RCR:Room Cavity Ratio						Coefficients of Utilization (CU)									
0.0	1.19	1.19	1.19	1.16	1.16	1.16	1.10	1.10	1.10	1.05	1.05	1.05	1.01	1.01	1.01	.98
1.0	1.03	.99	.95	1.01	.97	.93	.96	.93	.90	.92	.89	.87	.88	.86	.84	.82
2.0	.90	.83	.77	.88	.81	.76	.84	.79	.74	.80	.76	.72	.77	.73	.70	.68
3.0	.79	.70	.64	.77	.69	.63	.74	.67	.62	.71	.65	.61	.68	.63	.59	.57
4.0	.70	.61	.54	.68	.60	.53	.65	.58	.53	.63	.57	.52	.61	.55	.51	.49
5.0	.62	.53	.46	.61	.52	.46	.59	.51	.45	.56	.50	.45	.54	.49	.44	.42
6.0	.56	.47	.40	.55	.46	.40	.53	.45	.40	.51	.44	.39	.49	.43	.39	.37
7.0	.51	.42	.36	.50	.41	.35	.48	.41	.35	.46	.40	.35	.45	.39	.34	.32
8.0	.46	.38	.32	.45	.37	.32	.44	.37	.31	.43	.36	.31	.41	.35	.31	.29
9.0	.42	.34	.28	.42	.34	.28	.40	.33	.28	.39	.33	.28	.38	.32	.28	.26
10.0	.39	.31	.26	.38	.31	.26	.37	.30	.25	.36	.30	.25	.35	.29	.25	.23

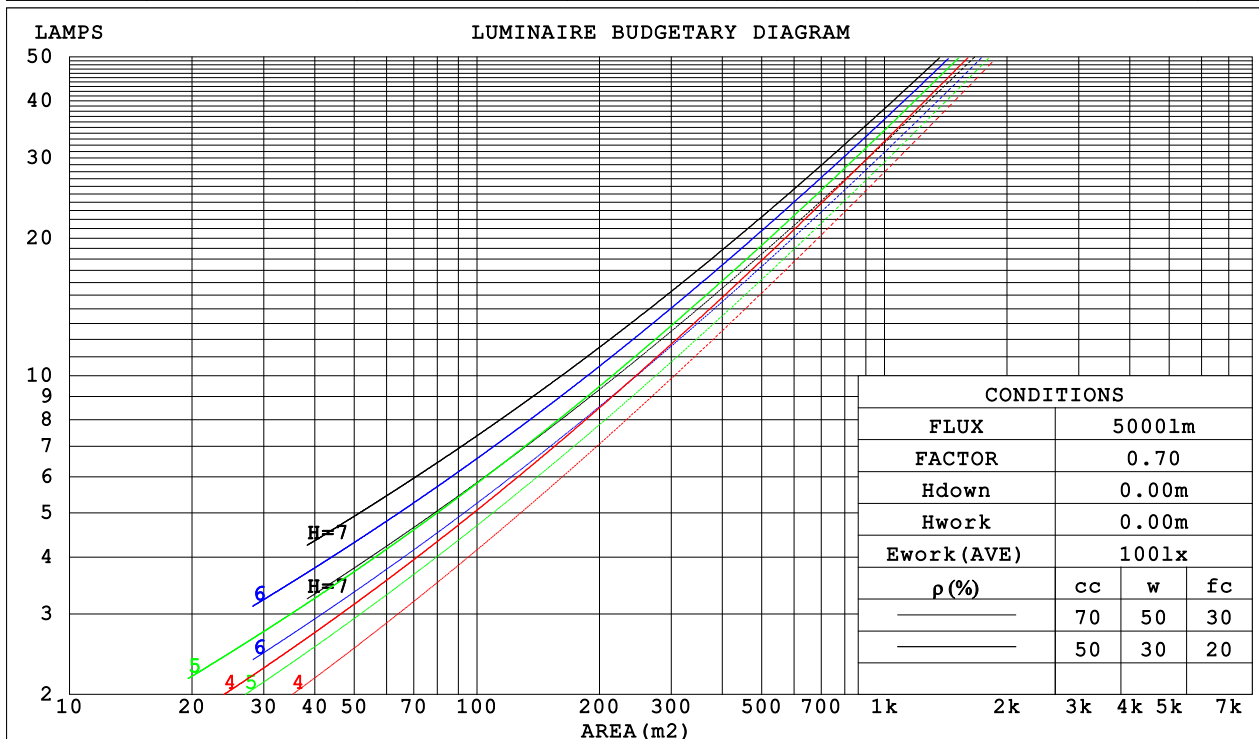

C Range: 0 - 360DEG  
 C Interval: 30.0DEG  
 Test Speed: HIGH  
 Temperature:25.3DEG  
 Operators:C  
 Test Date:2026-01-29

$\gamma$  Range: 0 - 180DEG  
 $\gamma$  Interval: 1.0DEG  
 Test System:EVERFINE GO-2000B\_V1 SYSTEM V2.0.404.7  
 Humidity:65.0%  
 Test Distance:4.430m [K=1.0000]  
 Remarks:

**WEC AND CCEC**

Test:U:219.47V I:0.1673A P:21.605W PF:0.5883 Freq:50.00Hz Lamp Flux:2757.01x1 lm					
NAME: LSLH-10%		TYPE:LSLH-10%		WEIGHT:	
SPEC.:		DIM.:		SERIAL No.:LSLH-10%	
MFR.: LSLH		SUR.:		Shielding Angle:	

ρcc	80%			70%			50%			30%			10%			0
ρw	50%	30%	10%	50%	30%	10%	50%	30%	10%	50%	30%	10%	50%	30%	10%	0
ρfc	20%			20%			20%			20%			20%			0
RCR	RCR:Room Cavity Ratio						Wall Exitance Coefficients (WEC)									
0.0																
1.0	.315	.179	.057	.308	.176	.056	.294	.169	.054	.281	.162	.052	.269	.156	.050	
2.0	.295	.161	.050	.288	.159	.049	.275	.153	.048	.264	.148	.046	.253	.143	.045	
3.0	.272	.145	.043	.266	.142	.043	.255	.138	.042	.244	.134	.041	.235	.130	.040	
4.0	.250	.130	.038	.245	.128	.038	.235	.125	.037	.226	.121	.037	.218	.118	.036	
5.0	.231	.118	.034	.227	.116	.034	.218	.113	.033	.210	.111	.033	.202	.108	.032	
6.0	.214	.107	.031	.210	.106	.031	.202	.104	.030	.195	.101	.030	.188	.099	.029	
7.0	.199	.099	.028	.196	.097	.028	.189	.095	.027	.182	.093	.027	.176	.091	.027	
8.0	.186	.091	.026	.183	.090	.025	.176	.088	.025	.170	.086	.025	.165	.085	.025	
9.0	.174	.084	.024	.171	.083	.023	.166	.082	.023	.160	.080	.023	.155	.079	.023	
10.0	.164	.079	.022	.161	.078	.022	.156	.076	.022	.151	.075	.021	.146	.074	.021	

ρcc	80%			70%			50%			30%			10%			0
ρw	50%	30%	10%	50%	30%	10%	50%	30%	10%	50%	30%	10%	50%	30%	10%	0
ρfc	20%			20%			20%			20%			20%			0
RCR	RCR:Room Cavity Ratio						Ceiling Cavity Exitance Coefficients (CCEC)									
0.0	.202	.202	.202	.173	.173	.173	.118	.118	.118	.068	.068	.068	.022	.022	.022	
1.0	.193	.168	.146	.165	.144	.126	.113	.099	.087	.065	.057	.050	.021	.018	.016	
2.0	.185	.144	.110	.158	.124	.095	.108	.086	.066	.062	.050	.039	.020	.016	.013	
3.0	.177	.126	.086	.152	.109	.075	.104	.076	.052	.060	.044	.031	.019	.014	.010	
4.0	.169	.113	.070	.145	.098	.061	.100	.068	.043	.058	.040	.025	.019	.013	.008	
5.0	.162	.103	.059	.139	.089	.052	.096	.062	.036	.055	.036	.022	.018	.012	.007	
6.0	.155	.094	.051	.133	.082	.045	.092	.057	.032	.053	.034	.019	.017	.011	.006	
7.0	.148	.088	.045	.127	.076	.040	.088	.053	.028	.051	.031	.017	.016	.010	.006	
8.0	.141	.082	.041	.122	.071	.036	.084	.050	.025	.049	.029	.015	.016	.010	.005	
9.0	.135	.077	.037	.117	.067	.033	.081	.047	.023	.047	.028	.014	.015	.009	.005	
10.0	.130	.073	.035	.112	.063	.030	.078	.044	.022	.045	.026	.013	.015	.009	.004	

C Range: 0 - 360DEG  
 C Interval: 30.0DEG  
 Test Speed: HIGH  
 Temperature:25.3DEG  
 Operator:C  
 Test Date:2026-01-29

γ Range: 0 - 180DEG  
 γ Interval: 1.0DEG  
 Test System:EVERFINE GO-2000B\_V1 SYSTEM V2.0.404.7  
 Humidity:65.0%  
 Test Distance:4.430m [K=1.0000]  
 Remarks:

**UGR(Unified Glare Rating) Table**

Test:U:219.47V I:0.1673A P:21.605W PF:0.5883 Freq:50.00Hz Lamp Flux:2757.01x1 lm										
NAME: LSLH-10%				TYPE:LSLH-10%				WEIGHT:		
SPEC.:				DIM.:				SERIAL No.:LSLH-10%		
MFR.: LSLH				SUR.:				Shielding Angle:		
ceiling/cavity	0.7	0.7	0.5	0.5	0.3	0.7	0.7	0.5	0.5	0.3
walls	0.5	0.3	0.5	0.3	0.3	0.5	0.3	0.5	0.3	0.3
working plane	0.2	0.2	0.2	0.2	0.2	0.2	0.2	0.2	0.2	0.2
Room dimensions	Viewed crosswise					Viewed endwise				
x = 2H y = 2H	15.8	17.3	16.1	17.6	17.8	15.5	17.0	15.8	17.2	17.5
3H	17.5	18.9	17.9	19.2	19.5	17.0	18.4	17.3	18.7	18.9
4H	18.3	19.6	18.6	19.9	20.2	17.6	18.9	18.0	19.2	19.5
6H	19.0	20.2	19.3	20.5	20.8	18.1	19.3	18.4	19.6	19.9
8H	19.2	20.4	19.6	20.7	21.1	18.2	19.4	18.6	19.7	20.0
12H	19.4	20.6	19.8	20.9	21.3	18.3	19.4	18.7	19.8	20.1
4H 2H	16.5	17.8	16.8	18.1	18.4	16.2	17.6	16.6	17.9	18.1
3H	18.4	19.6	18.8	19.9	20.2	18.0	19.2	18.4	19.5	19.9
4H	19.3	20.4	19.7	20.7	21.1	18.8	19.9	19.2	20.2	20.6
6H	20.1	21.1	20.6	21.5	21.9	19.4	20.4	19.8	20.7	21.1
8H	20.5	21.3	20.9	21.7	22.2	19.6	20.5	20.1	20.9	21.3
12H	20.8	21.6	21.2	22.0	22.4	19.8	20.6	20.2	21.0	21.4
8H 4H	19.7	20.6	20.1	21.0	21.4	19.2	20.1	19.7	20.5	20.9
6H	20.7	21.4	21.2	21.9	22.3	20.1	20.8	20.6	21.3	21.7
8H	21.2	21.8	21.6	22.3	22.7	20.4	21.1	20.9	21.5	22.0
12H	21.6	22.1	22.1	22.6	23.1	20.7	21.3	21.2	21.7	22.2
12H 4H	19.7	20.5	20.2	20.9	21.4	19.3	20.1	19.8	20.5	21.0
6H	20.8	21.4	21.3	21.9	22.4	20.2	20.9	20.7	21.3	21.8
8H	21.3	21.9	21.8	22.4	22.9	20.7	21.2	21.2	21.7	22.2
Variations with the observer position at spacings:										
S = 1.0H	+ 0.1 / - 0.2					+ 0.1 / - 0.2				
1.5H	+ 0.2 / - 0.3					+ 0.2 / - 0.4				
2.0H	+ 0.1 / - 0.3					+ 0.2 / - 0.5				

CIE Pub.117, 2145 lm Total Lamp Luminous Flux Corrected (8log(F/F0) = 2.7)

C Range: 0 - 360DEG	γ Range: 0 - 180DEG
C Interval: 30.0DEG	γ Interval: 1.0DEG
Test Speed: HIGH	Test System:EVERFINE GO-2000B_V1 SYSTEM V2.0.404.7
Temperature:25.3DEG	Humidity:65.0%
Operators:C	Test Distance:4.430m [K=1.0000]
Test Date:2026-01-29	Remarks:

**UTILIZATION FACTORS TABLE**

Test:U:219.47V I:0.1673A P:21.605W PF:0.5883 Freq:50.00Hz Lamp Flux:2757.01x1 lm		
NAME: LSLH-10%	TYPE:LSLH-10%	WEIGHT:
SPEC.:	DIM.:	SERIAL No.:LSLH-10%
MFR.: LSLH	SUR.:	Shielding Angle:

REFLECTANCE										
Ceiling	0.8	0.8	0.8	0.7	0.7	0.7	0.5	0.5	0.5	0
Walls	0.7	0.5	0.3	0.7	0.5	0.3	0.7	0.5	0.3	0
Working plane	0.2	0.2	0.2	0.2	0.2	0.2	0.2	0.2	0.2	0
ROOM INDEX	UTILIZATION FACTORS (PERCENT) $k(RI) \times RCR = 5$									
k = 0.60	57	45	38	56	45	38	55	44	38	31
0.80	67	55	48	66	55	47	64	54	47	40
1.00	75	64	56	74	63	56	71	65	56	48
1.25	82	72	64	81	71	64	78	69	63	55
1.50	87	77	70	85	76	69	82	74	68	60
2.00	94	85	79	92	84	78	88	82	76	68
2.50	98	90	84	96	89	83	92	86	81	72
3.00	101	94	89	99	93	88	95	90	85	76
4.00	105	100	95	103	98	93	98	94	90	81
5.00	108	103	99	105	101	97	101	97	94	84
ROOM INDEX	UF(total)									Direct
According to DIN EN 13032-2 2004			Suspended				SHRNOM = 1.25			

C Range: 0 - 360DEG  
C Interval: 30.0DEG  
Test Speed: HIGH  
Temperature:25.3DEG  
Operators:C  
Test Date:2026-01-29

$\gamma$  Range: 0 - 180DEG  
 $\gamma$  Interval: 1.0DEG  
Test System:EVERFINE GO-2000B\_V1 SYSTEM V2.0.404.7  
Humidity:65.0%  
Test Distance:4.430m [K=1.0000]  
Remarks:

**ISOCANDELA DIAGRAM**

Test:U:219.47V I:0.1673A P:21.605W PF:0.5883 Freq:50.00Hz Lamp Flux:2757.01x1 lm		
NAME: LSLH-10%	TYPE:LSLH-10%	WEIGHT:
SPEC.:	DIM.:	SERIAL No.:LSLH-10%
MFR.: LSLH	SUR.:	Shielding Angle:

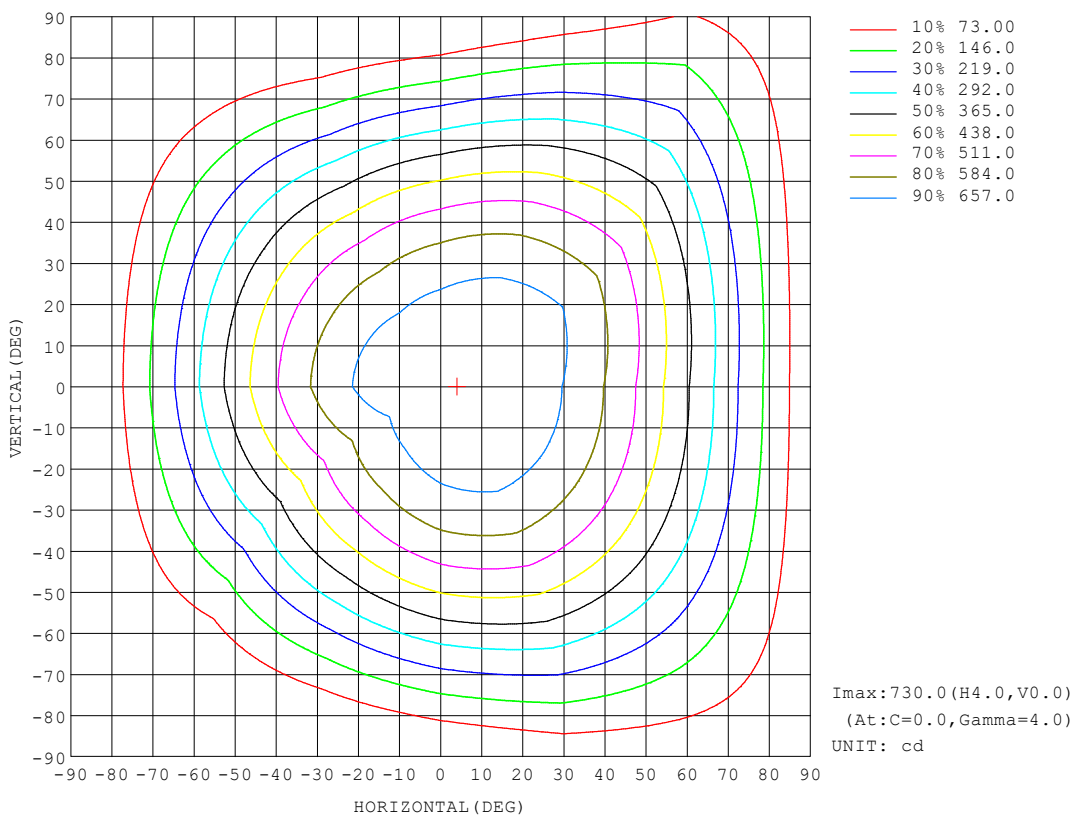

C Range: 0 - 360DEG  
 C Interval: 30.0DEG  
 Test Speed: HIGH  
 Temperature:25.3DEG  
 Operators:C  
 Test Date:2026-01-29

γ Range: 0 - 180DEG  
 γ Interval: 1.0DEG  
 Test System:EVERFINE GO-2000B\_V1 SYSTEM V2.0.404.7  
 Humidity:65.0%  
 Test Distance:4.430m [K=1.0000]  
 Remarks:

**AAI Figure**

Test:U:219.47V I:0.1673A P:21.605W PF:0.5883 Freq:50.00Hz Lamp Flux:2757.01x1 lm		
NAME: LSLH-10%	TYPE:LSLH-10%	WEIGHT:
SPEC.:	DIM.:	SERIAL No.:LSLH-10%
MFR.: LSLH	SUR.:	Shielding Angle:

Flux out:1554 lm

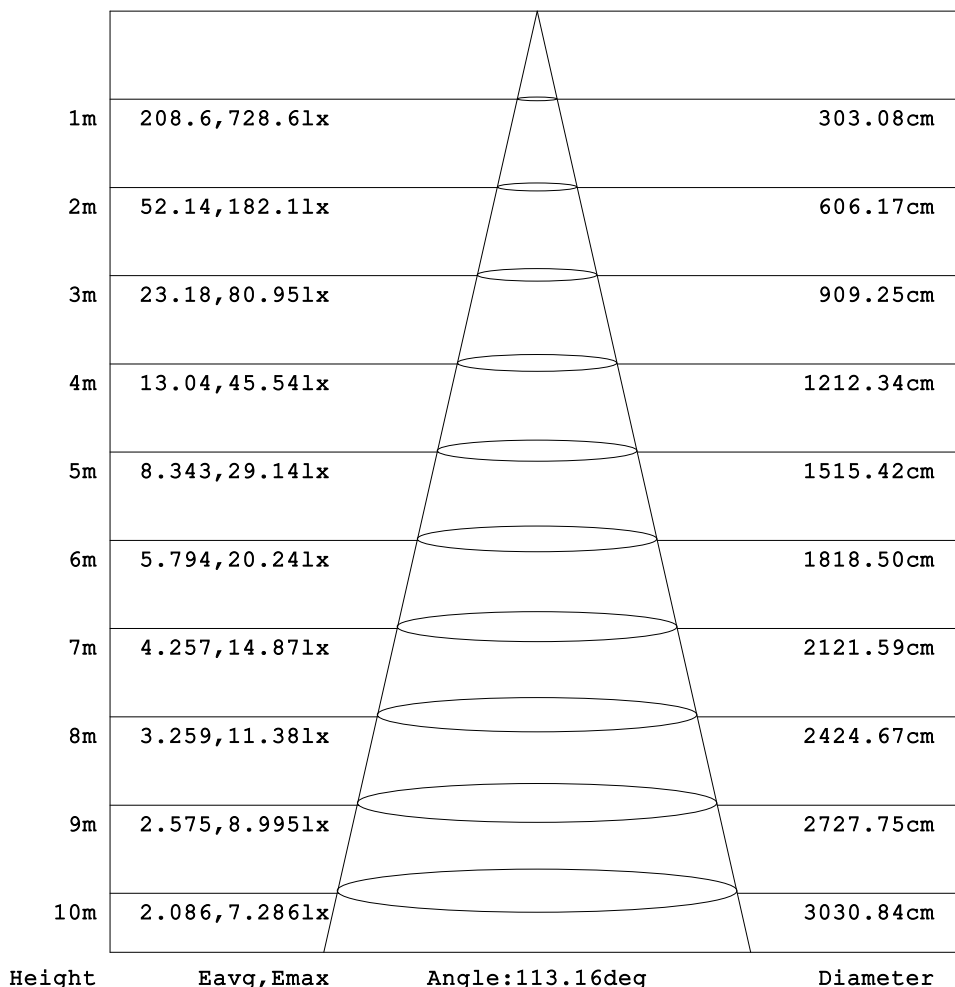

Note:The Curves indicate the illuminated area and the average illumination when the luminaire is at different distance.

C Range: 0 - 360DEG  
C Interval: 30.0DEG  
Test Speed: HIGH  
Temperature:25.3DEG  
Operators:C  
Test Date:2026-01-29

γ Range: 0 - 180DEG  
γ Interval: 1.0DEG  
Test System:EVERFINE GO-2000B\_V1 SYSTEM V2.0.404.7  
Humidity:65.0%  
Test Distance:4.430m [K=1.0000]  
Remarks:

**ISOLUX DIAGRAM**

Test:U:219.47V I:0.1673A P:21.605W PF:0.5883 Freq:50.00Hz Lamp Flux:2757.01x1 lm		
NAME: LSLH-10%	TYPE:LSLH-10%	WEIGHT:
SPEC.:	DIM.:	SERIAL No.:LSLH-10%
MFR.: LSLH	SUR.:	Shielding Angle:

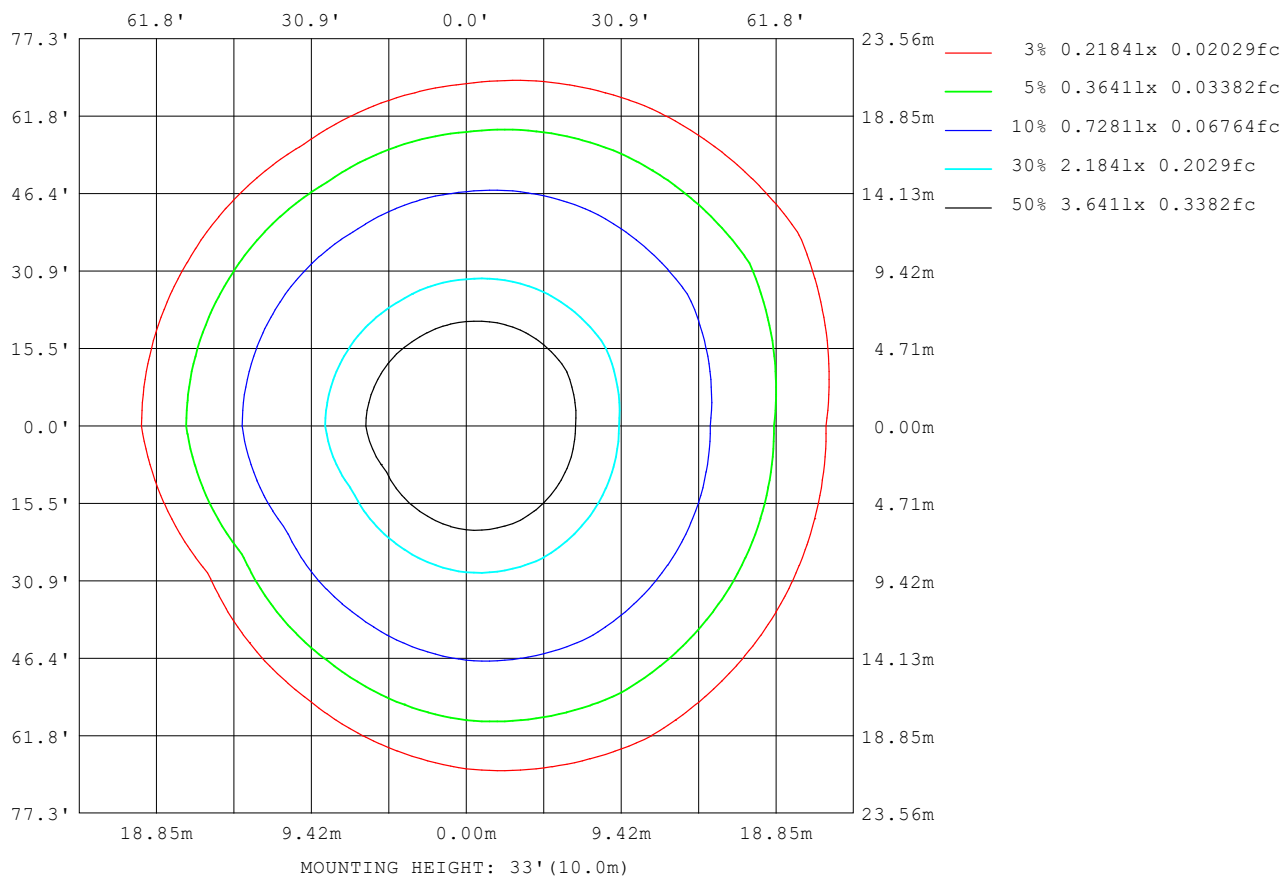

C Range: 0 - 360DEG  
C Interval: 30.0DEG  
Test Speed: HIGH  
Temperature:25.3DEG  
Operators:C  
Test Date:2026-01-29

$\gamma$  Range: 0 - 180DEG  
 $\gamma$  Interval: 1.0DEG  
Test System:EVERFINE GO-2000B\_V1 SYSTEM V2.0.404.7  
Humidity:65.0%  
Test Distance:4.430m [K=1.0000]  
Remarks:

**LED Avg.L Report**

Test:U:219.47V I:0.1673A P:21.605W PF:0.5883 Freq:50.00Hz Lamp Flux:2757.01x1 lm		
NAME: LSLH-10%	TYPE:LSLH-10%	WEIGHT:
SPEC.:	DIM.:	SERIAL No.:LSLH-10%
MFR.: LSLH	SUR.:	Shielding Angle:

AvgL	cd/m2
L_0~180 (65) av	1741
L_0~180 (75) av	1541
L_0~180 (85) av	1189
L_90~270 (65) av	1734
L_90~270 (75) av	1516
L_90~270 (85) av	1030
L_45 (65) av	1745
L_45 (75) av	1566
L_45 (85) av	1584

Standard: GB/T 29293-2012

C Range: 0 - 360DEG  
 C Interval: 30.0DEG  
 Test Speed: HIGH  
 Temperature:25.3DEG  
 Operators:C  
 Test Date:2026-01-29

γ Range: 0 - 180DEG  
 γ Interval: 1.0DEG  
 Test System:EVERFINE GO-2000B\_V1 SYSTEM V2.0.404.7  
 Humidity:65.0%  
 Test Distance:4.430m [K=1.0000]  
 Remarks:

**Planar Illuminance Curve**

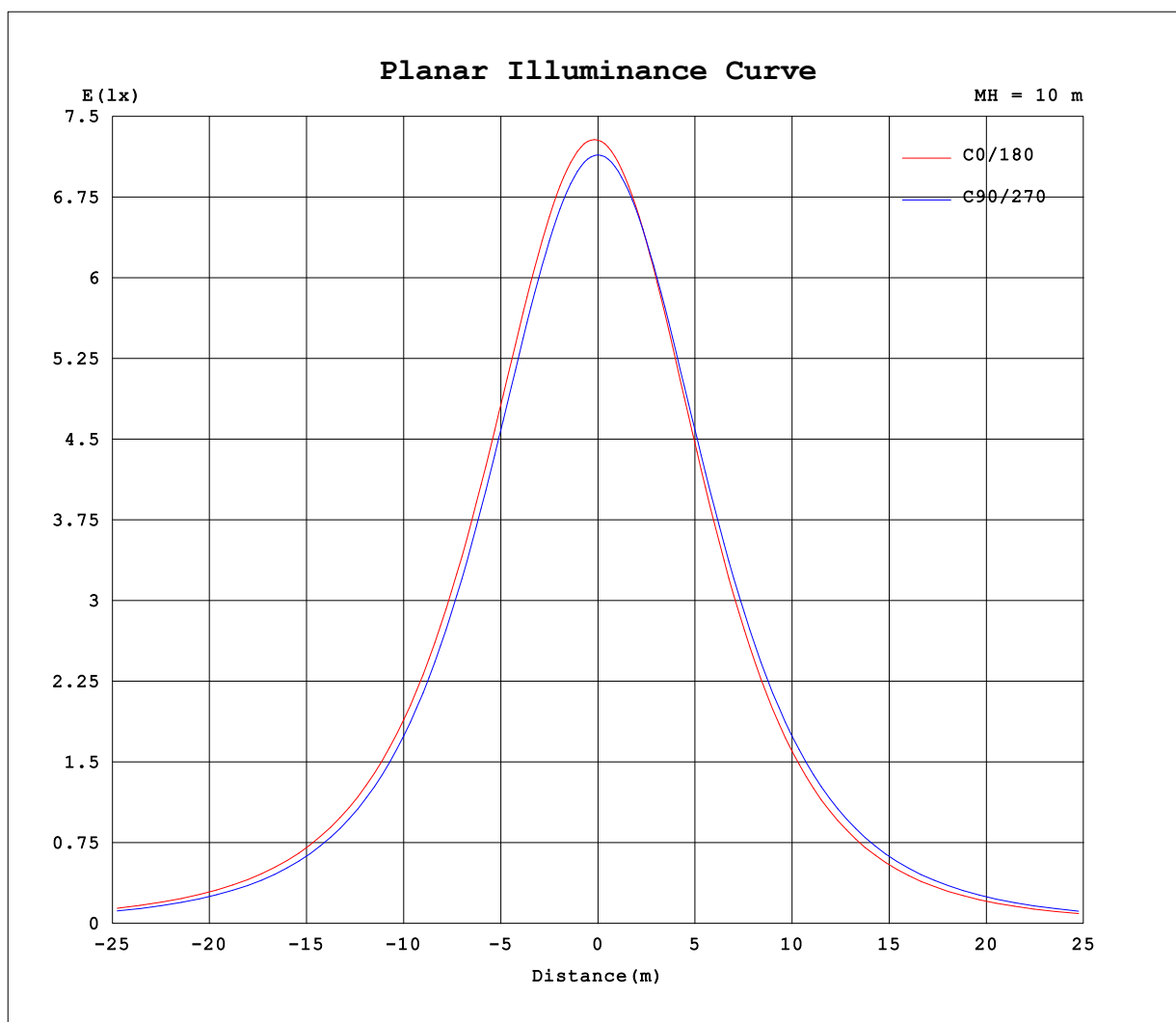

C Range: 0 - 360DEG  
 C Interval: 30.0DEG  
 Test Speed: HIGH  
 Temperature: 25.3DEG  
 Operators: C  
 Test Date: 2026-01-29

γ Range: 0 - 180DEG  
 γ Interval: 1.0DEG  
 Test System: EVERFINE GO-2000B\_V1 SYSTEM V2.0.404.7  
 Humidity: 65.0%  
 Test Distance: 4.430m [K=1.0000]  
 Remarks:

**LUMINOUS DISTRIBUTION INTENSITY DATA**

Test:U:219.47V I:0.1673A P:21.605W PF:0.5883 Freq:50.00Hz Lamp Flux:2757.01x1 lm		
NAME: LSLH-10%	TYPE:LSLH-10%	WEIGHT:
SPEC.:	DIM.:	SERIAL No.:LSLH-10%
MFR.: LSLH	SUR.:	Shielding Angle:

Table--1

UNIT: cd

C (DEG) \ γ (DEG)	0	30	60	90	120	150	180	210	240	270	300	330							
0	728	724	718	714	712	712	728	724	718	714	712	712							
5	730	726	720	712	703	698	721	717	712	712	716	721							
10	726	723	717	704	688	679	708	704	700	704	715	724							
15	717	714	709	692	669	653	690	686	682	692	708	722							
20	702	700	695	673	643	622	665	661	659	674	697	714							
25	681	680	676	649	611	584	635	631	630	650	680	701							
30	654	654	650	619	574	541	598	594	595	620	657	682							
35	621	622	618	583	530	493	555	551	553	584	627	657							
40	581	583	580	541	482	440	506	503	506	541	591	625							
45	536	538	536	493	429	384	453	450	454	493	549	587							
50	485	488	486	440	372	325	396	393	398	440	501	543							
55	430	433	432	383	313	265	337	334	338	382	448	493							
60	371	375	374	324	253	205	276	273	277	322	391	439							
65	310	315	313	263	193	147	215	211	215	260	330	381							
70	248	253	251	202	135	90.2	155	151	155	198	268	320							
75	187	192	190	143	79.8	39.2	97.6	93.9	96.0	137	206	258							
80	128	132	131	86.1	29.4	2.20	44.9	40.7	43.1	80.3	145	195							
85	71.8	75.7	75.1	35.3	2.31	2.46	2.19	2.19	2.18	28.8	86.4	135							
90	20.8	25.0	24.5	2.27	2.57	2.79	2.40	2.48	2.47	2.32	34.1	77.8							
95	2.19	2.23	2.29	2.51	2.89	3.17	2.82	2.90	2.85	2.62	2.40	25.9							
100	2.52	2.54	2.58	2.87	3.30	3.57	3.28	3.34	3.27	3.00	2.68	2.46							
105	2.97	2.95	2.96	3.30	3.74	4.02	3.71	3.77	3.67	3.40	3.00	2.75							
110	3.42	3.39	3.39	3.73	4.18	4.46	4.14	4.21	4.08	3.80	3.39	3.13							
115	3.93	3.88	3.87	4.19	4.67	4.97	4.62	4.70	4.56	4.24	3.84	3.60							
120	4.46	4.40	4.37	4.67	5.13	5.52	5.07	5.15	4.99	4.64	4.26	4.02							
125	4.96	4.87	4.85	5.06	5.54	6.02	5.47	5.58	5.34	4.99	4.67	4.43							
130	5.34	5.25	5.21	5.40	5.85	6.32	5.87	5.99	5.68	5.33	5.04	4.81							
135	5.69	5.62	5.54	5.71	6.13	6.53	6.18	6.24	5.92	5.59	5.32	5.11							
140	6.01	5.95	5.84	5.98	6.36	6.61	6.36	6.42	6.14	5.85	5.60	5.42							
145	6.25	6.25	6.15	6.25	6.59	6.76	6.60	6.50	6.37	6.10	5.89	5.76							
150	6.54	6.57	6.50	6.54	6.84	6.73	6.88	6.37	6.61	6.39	6.20	6.08							
155	6.85	6.93	6.85	6.84	7.07	7.03	7.18	6.68	6.89	6.71	6.55	6.43							
160	7.19	7.32	7.15	7.04	7.27	7.48	7.54	7.17	7.15	6.98	6.91	6.81							
165	7.55	7.67	7.38	7.23	7.46	7.76	7.93	7.62	7.39	7.20	7.21	7.23							
170	7.74	7.83	7.46	7.31	7.53	7.85	8.22	7.90	7.54	7.35	7.37	7.52							
175	7.62	7.53	7.14	7.01	7.15	7.48	7.93	7.75	7.31	7.15	7.17	7.43							
180	7.41	7.28	6.88	6.75	6.79	7.08	7.43	7.28	6.88	6.73	6.79	7.09							

C Range: 0 - 360DEG  
C Interval: 30.0DEG  
Test Speed: HIGH  
Temperature:25.3DEG  
Operators:C  
Test Date:2026-01-29

γ Range: 0 - 180DEG  
γ Interval: 1.0DEG  
Test System:EVERFINE GO-2000B\_V1 SYSTEM V2.0.404.7  
Humidity:65.0%  
Test Distance:4.430m [K=1.0000]  
Remarks:

**LUMINAIRE PHOTOMETRIC TEST REPORT**

Test:U:219.37V I:0.8197A P:176.03W PF:0.9789 Freq:50.00Hz Lamp Flux:22915.59x1 lm		
NAME: LSLH-175W	TYPE:	WEIGHT:
SPEC.:	DIM.:	SERIAL No.:LSLH-170W
MFR.: LSLH	SUR.:	Shielding Angle:

DATA OF LAMP		PHOTOMETRIC DATA Eff: 130.18 lm/W			
MODEL	LSLH-175W	Imax (cd)	6934	S/MH (C0/180)	1.20
NOMINAL POWER (W)	175	LOR (%)	100.0	S/MH (C90/270)	1.30
RATED VOLTAGE (V)	220	TOTAL FLUX (lm)	22916	η UP, DN (C0-180)	0.7, 49.9
NOMINAL FLUX (lm)	22915.6	CIE CLASS	DIRECT	η UP, DN (C180-360)	0.7, 48.6
LAMPS INSIDE	1	η up (%)	1.5	CIBSE SHR NOM	1.25
TEST VOLTAGE (V)	220	η down (%)	98.5	CIBSE SHR MAX	1.35

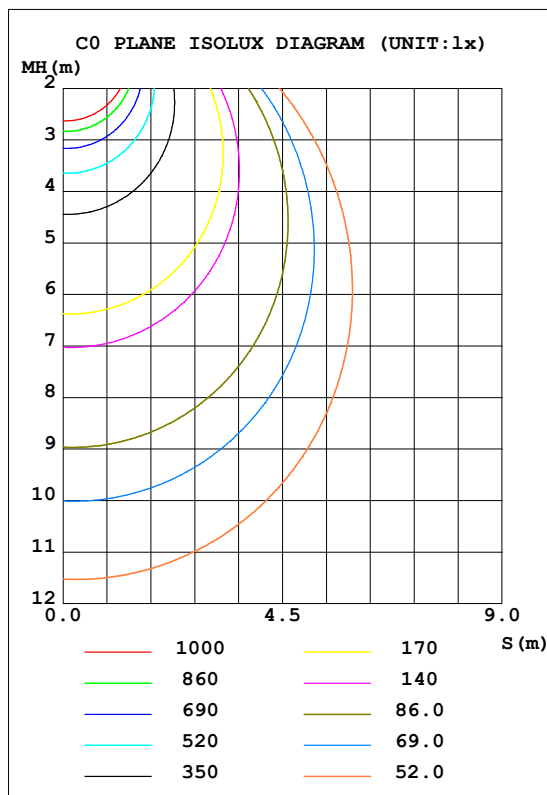
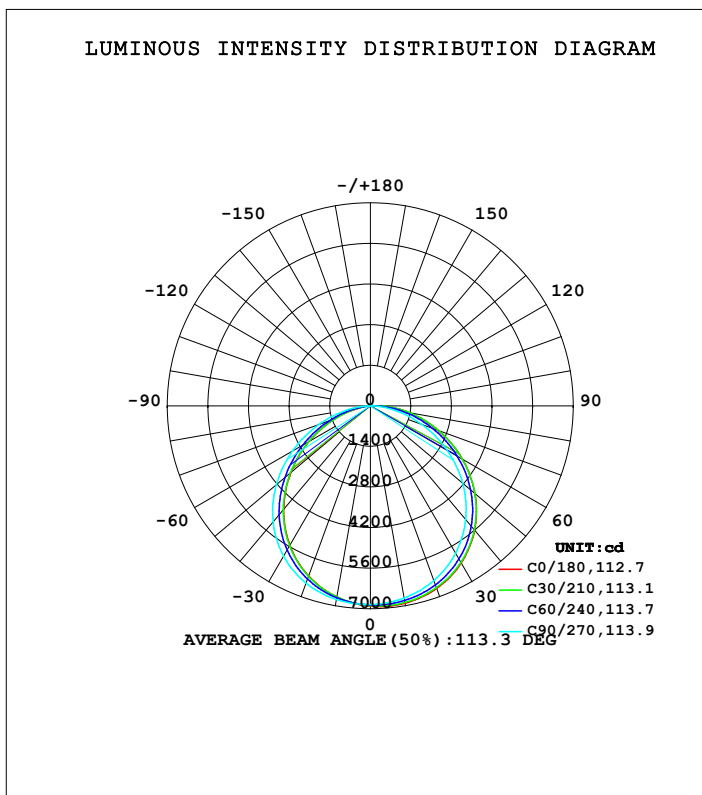

C Range: 0 - 360DEG  
C Interval: 30.0DEG  
Test Speed: HIGH  
Temperature: 25.3DEG  
Operators: H  
Test Date: 2025-07-24

γ Range: 0 - 180DEG  
γ Interval: 1.0DEG  
Test System: EVERFINE GO-2000B\_V1 SYSTEM V2.0.404.7  
Humidity: 65.0%  
Test Distance: 4.430m [K=1.0000]  
Remarks:

**ZONAL FLUX DIAGRAM**

ZONAL FLUX DIAGRAM:

$\gamma$	C0	C45	C90	C135	C180	C225	C270	C315	$\gamma$	$\Phi$ zone	$\Phi$ total	%lum, lamp
10	6908	6848	6729	6615	6690	6703	6781	6874	0- 10	650.7	650.7	3.2,3.2
20	6697	6617	6409	6169	6243	6304	6501	6694	10- 20	1874	2524	12.4,12.4
30	6264	6171	5874	5497	5557	5662	5987	6288	20- 30	2862	5386	26.5,26.5
40	5595	5497	5116	4612	4651	4786	5221	5638	30- 40	3471	8858	43.6,43.6
50	4708	4610	4159	3565	3581	3725	4233	4753	40- 50	3603	12460	61.3,61.3
60	3651	3553	3058	2429	2432	2561	3091	3683	50- 60	3237	15698	77.3,77.3
70	2500	2404	1902	1303	1298	1398	1894	2509	60- 70	2453	18150	89.3,89.3
80	1351	1264	807.5	300.2	285.1	355.4	769.6	1342	70- 80	1420	19570	96.3,96.3
90	321.8	258.1	20.32	22.85	22.54	23.26	21.03	302.0	80- 90	451.2	20021	98.5,98.5
100	21.85	23.01	25.78	29.68	30.00	29.97	26.16	23.19	90-100	47.73	20069	98.8,98.8
110	30.57	31.25	34.16	38.29	38.52	38.22	34.01	30.85	100-110	31.76	20101	98.9,98.9
120	41.29	41.54	43.91	48.64	48.25	47.93	42.91	40.30	110-120	39.34	20140	99.1,99.1
130	49.35	49.31	50.51	55.94	55.06	53.95	48.21	46.56	120-130	43.02	20183	99.3,99.3
140	55.06	55.19	55.53	59.64	59.56	57.91	53.04	52.12	130-140	41.54	20225	99.5,99.5
150	60.54	61.27	60.81	62.44	64.48	61.09	58.20	57.99	140-150	36.64	20261	99.7,99.7
160	65.95	68.02	65.86	68.32	70.34	66.58	63.97	64.66	150-160	29.35	20291	99.9,99.9
170	71.53	72.40	68.59	71.40	76.39	72.05	68.04	70.18	160-170	19.62	20310	100,100
180	67.87	65.16	62.12	63.96	67.90	65.17	62.11	63.96	170-180	6.697	20317	100,100
DEG	LUMINOUS INTENSITY:cd									UNIT:lm		

C Range: 0 - 360DEG  
 C Interval: 30.0DEG  
 Test Speed: HIGH  
 Temperature:25.3DEG  
 Operators:H  
 Test Date:2025-07-24

$\gamma$  Range: 0 - 180DEG  
 $\gamma$  Interval: 1.0DEG  
 Test System:EVERFINE GO-2000B\_V1 SYSTEM V2.0.404.7  
 Humidity:65.0%  
 Test Distance:4.430m [K=1.0000]  
 Remarks:

**LUMINANCE LIMITATION CURVES**

Test:U:219.37V I:0.8197A P:176.03W PF:0.9789 Freq:50.00Hz Lamp Flux:22915.59x1 lm		
NAME: LSLH-175W	TYPE:	WEIGHT:
SPEC.:	DIM.:	SERIAL No.:LSLH-170W
MFR.: LSLH	SUR.:	Shielding Angle:

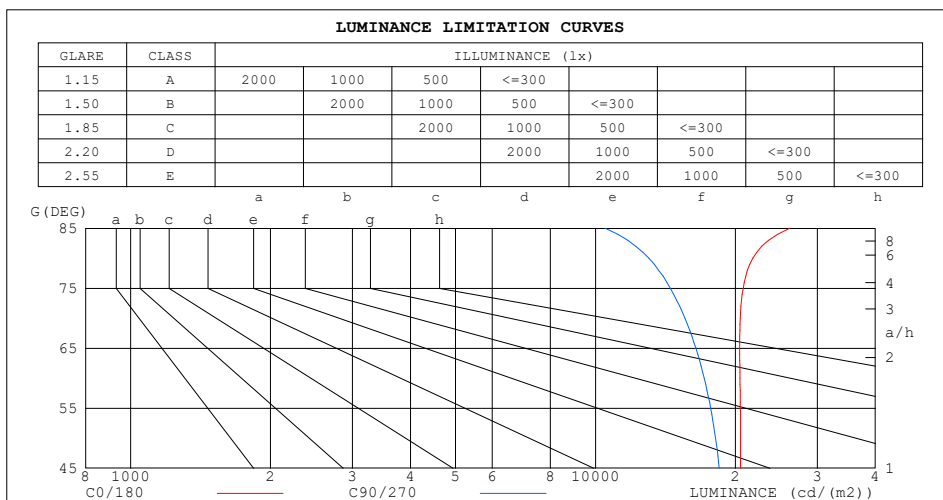

LUMINANCE cd/(m2)		
G (DEG)	C0/180	C90/270
85	26173	10489
80	21801	13029
75	20790	14487
70	20481	15579
65	20422	16441
60	20461	17137
55	20504	17690
50	20521	18128
45	20516	18466

C Range: 0 - 360DEG  
C Interval: 30.0DEG  
Test Speed: HIGH  
Temperature:25.3DEG  
Operators:H  
Test Date:2025-07-24

γ Range: 0 - 180DEG  
γ Interval: 1.0DEG  
Test System:EVERFINE GO-2000B\_V1 SYSTEM V2.0.404.7  
Humidity:65.0%  
Test Distance:4.430m [K=1.0000]  
Remarks:

**CU AND LUMINAIRE BUDGETARY ESTIMATE DIAGRAM**

Test:U:219.37V I:0.8197A P:176.03W PF:0.9789 Freq:50.00Hz Lamp Flux:22915.59x1 lm		
NAME: LSLH-175W	TYPE:	WEIGHT:
SPEC.:	DIM.:	SERIAL No.:LSLH-170W
MFR.: LSLH	SUR.:	Shielding Angle:

$\rho_{cc}$	80%			70%			50%			30%			10%			0
$\rho_w$	50%	30%	10%	50%	30%	10%	50%	30%	10%	50%	30%	10%	50%	30%	10%	0
$\rho_{fc}$	20%			20%			20%			20%			20%			0
RCR	RCR:Room Cavity Ratio						Coefficients of Utilization(CU)									
0.0	1.19	1.19	1.19	1.16	1.16	1.16	1.10	1.10	1.10	1.05	1.05	1.05	1.01	1.01	1.01	.99
1.0	1.03	.99	.95	1.01	.97	.93	.96	.93	.90	.92	.90	.87	.88	.86	.84	.82
2.0	.90	.83	.77	.88	.82	.76	.84	.79	.74	.81	.76	.72	.77	.74	.70	.68
3.0	.79	.71	.64	.77	.70	.63	.74	.67	.62	.71	.65	.61	.68	.64	.60	.57
4.0	.70	.61	.54	.68	.60	.54	.66	.58	.53	.63	.57	.52	.61	.55	.51	.49
5.0	.62	.53	.47	.61	.53	.46	.59	.51	.46	.57	.50	.45	.55	.49	.44	.42
6.0	.56	.47	.41	.55	.47	.40	.53	.45	.40	.51	.44	.39	.49	.44	.39	.37
7.0	.51	.42	.36	.50	.42	.36	.48	.41	.35	.47	.40	.35	.45	.39	.34	.32
8.0	.46	.38	.32	.46	.37	.32	.44	.37	.31	.43	.36	.31	.41	.35	.31	.29
9.0	.42	.34	.29	.42	.34	.29	.41	.33	.28	.39	.33	.28	.38	.32	.28	.26
10.0	.39	.31	.26	.39	.31	.26	.37	.30	.26	.36	.30	.25	.35	.30	.25	.24

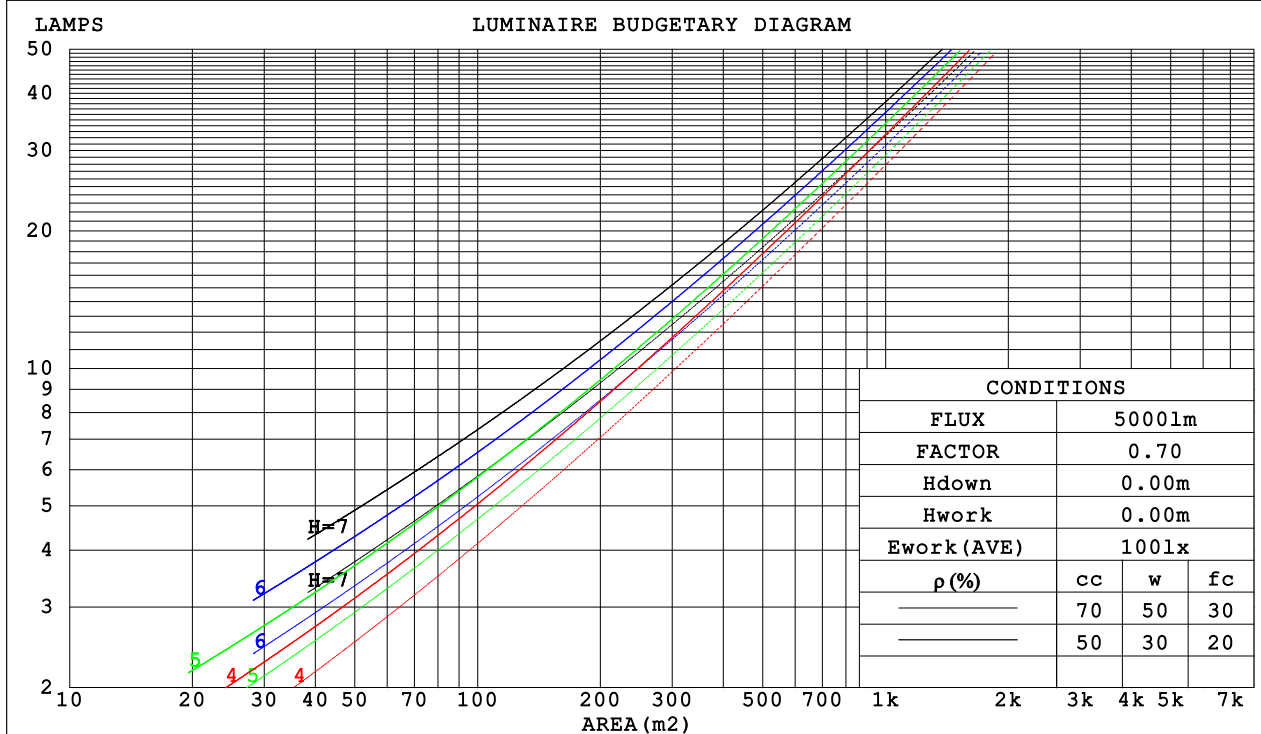

C Range: 0 - 360DEG  
C Interval: 30.0DEG  
Test Speed: HIGH  
Temperature:25.3DEG  
Operators:H  
Test Date:2025-07-24

$\gamma$  Range: 0 - 180DEG  
 $\gamma$  Interval: 1.0DEG  
Test System:EVERFINE GO-2000B\_V1 SYSTEM V2.0.404.7  
Humidity:65.0%  
Test Distance:4.430m [K=1.0000]  
Remarks:

**WEC AND CCEC**

Test:U:219.37V I:0.8197A P:176.03W PF:0.9789 Freq:50.00Hz Lamp Flux:22915.59x1 lm		
NAME: LSLH-175W	TYPE:	WEIGHT:
SPEC.:	DIM.:	SERIAL No.:LSLH-170W
MFR.: LSLH	SUR.:	Shielding Angle:

ρcc	80%			70%			50%			30%			10%			0
ρw	50%	30%	10%	50%	30%	10%	50%	30%	10%	50%	30%	10%	50%	30%	10%	0
ρfc	20%			20%			20%			20%			20%			0
RCR	RCR:Room Cavity Ratio						Wall Exitance Coefficients (WEC)									
0.0																
1.0	.313	.178	.056	.306	.174	.055	.292	.167	.053	.279	.161	.052	.267	.155	.050	
2.0	.293	.161	.049	.287	.158	.049	.274	.152	.047	.263	.147	.046	.252	.143	.045	
3.0	.271	.144	.043	.265	.142	.043	.254	.138	.042	.244	.134	.041	.234	.130	.040	
4.0	.250	.130	.038	.244	.128	.038	.235	.124	.037	.225	.121	.037	.217	.118	.036	
5.0	.231	.118	.034	.226	.116	.034	.217	.113	.033	.209	.110	.033	.201	.108	.032	
6.0	.214	.107	.031	.210	.106	.030	.202	.103	.030	.195	.101	.030	.188	.099	.029	
7.0	.199	.098	.028	.195	.097	.028	.188	.095	.027	.182	.093	.027	.175	.091	.027	
8.0	.186	.091	.026	.182	.090	.025	.176	.088	.025	.170	.086	.025	.165	.085	.025	
9.0	.174	.084	.024	.171	.083	.023	.165	.082	.023	.160	.080	.023	.155	.079	.023	
10.0	.164	.078	.022	.161	.078	.022	.156	.076	.021	.151	.075	.021	.146	.074	.021	

ρcc	80%			70%			50%			30%			10%			0
ρw	50%	30%	10%	50%	30%	10%	50%	30%	10%	50%	30%	10%	50%	30%	10%	0
ρfc	20%			20%			20%			20%			20%			0
RCR	RCR:Room Cavity Ratio						Ceiling Cavity Exitance Coefficients (CCEC)									
0.0	.202	.202	.202	.172	.172	.172	.118	.118	.118	.068	.068	.068	.022	.022	.022	
1.0	.192	.167	.145	.164	.144	.125	.112	.099	.086	.065	.057	.050	.021	.018	.016	
2.0	.184	.143	.109	.157	.123	.094	.108	.085	.066	.062	.050	.039	.020	.016	.013	
3.0	.176	.126	.085	.151	.108	.074	.104	.075	.052	.060	.044	.031	.019	.014	.010	
4.0	.168	.112	.070	.144	.097	.060	.099	.068	.043	.057	.040	.025	.018	.013	.008	
5.0	.161	.102	.059	.138	.088	.051	.095	.062	.036	.055	.036	.021	.018	.012	.007	
6.0	.154	.094	.051	.132	.081	.044	.091	.057	.031	.053	.033	.019	.017	.011	.006	
7.0	.147	.087	.045	.126	.075	.039	.087	.053	.028	.051	.031	.016	.016	.010	.005	
8.0	.140	.081	.040	.121	.070	.035	.084	.049	.025	.049	.029	.015	.016	.010	.005	
9.0	.134	.076	.037	.116	.066	.032	.080	.046	.023	.047	.027	.014	.015	.009	.004	
10.0	.129	.072	.034	.111	.062	.030	.077	.044	.021	.045	.026	.013	.015	.009	.004	

C Range: 0 - 360DEG  
 C Interval: 30.0DEG  
 Test Speed: HIGH  
 Temperature:25.3DEG  
 Operators:H  
 Test Date:2025-07-24

γ Range: 0 - 180DEG  
 γ Interval: 1.0DEG  
 Test System:EVERFINE GO-2000B\_V1 SYSTEM V2.0.404.7  
 Humidity:65.0%  
 Test Distance:4.430m [K=1.0000]  
 Remarks:

**UGR(Unified Glare Rating) Table**

Test:U:219.37V I:0.8197A P:176.03W PF:0.9789 Freq:50.00Hz Lamp Flux:22915.59x1 lm										
NAME: LSLH-175W					TYPE:			WEIGHT:		
SPEC.:					DIM.:			SERIAL No.:LSLH-170W		
MFR.: LSLH					SUR.:			Shielding Angle:		
ceiling/cavity	0.7	0.7	0.5	0.5	0.3	0.7	0.7	0.5	0.5	0.3
walls	0.5	0.3	0.5	0.3	0.3	0.5	0.3	0.5	0.3	0.3
working plane	0.2	0.2	0.2	0.2	0.2	0.2	0.2	0.2	0.2	0.2
Room dimensions	Viewed crosswise					Viewed endwise				
x = 2H y = 2H	23.8	25.3	24.1	25.6	25.8	23.2	24.7	23.5	24.9	25.2
3H	25.6	27.0	25.9	27.3	27.5	24.7	26.1	25.0	26.4	26.6
4H	26.4	27.8	26.8	28.0	28.3	25.3	26.6	25.7	26.9	27.2
6H	27.2	28.4	27.5	28.7	29.0	25.8	27.0	26.1	27.3	27.6
8H	27.5	28.7	27.8	29.0	29.3	25.9	27.1	26.3	27.4	27.7
12H	27.7	28.9	28.1	29.2	29.6	26.0	27.1	26.3	27.4	27.8
4H 2H	24.5	25.8	24.8	26.1	26.4	24.0	25.3	24.3	25.6	25.9
3H	26.5	27.6	26.9	28.0	28.3	25.7	26.9	26.1	27.2	27.6
4H	27.5	28.5	27.9	28.9	29.2	26.5	27.6	26.9	27.9	28.3
6H	28.3	29.3	28.8	29.7	30.0	27.1	28.0	27.5	28.4	28.8
8H	28.7	29.6	29.2	30.0	30.4	27.3	28.2	27.7	28.6	29.0
12H	29.1	29.9	29.5	30.3	30.7	27.4	28.2	27.9	28.6	29.1
8H 4H	27.8	28.7	28.2	29.1	29.5	27.0	27.8	27.4	28.2	28.7
6H	28.9	29.6	29.3	30.0	30.5	27.8	28.5	28.2	28.9	29.4
8H	29.4	30.1	29.9	30.5	31.0	28.1	28.7	28.6	29.2	29.7
12H	29.9	30.5	30.4	31.0	31.5	28.3	28.9	28.8	29.4	29.9
12H 4H	27.8	28.6	28.3	29.0	29.5	27.0	27.8	27.5	28.3	28.7
6H	29.0	29.6	29.5	30.1	30.6	27.9	28.6	28.4	29.0	29.5
8H	29.6	30.1	30.1	30.6	31.1	28.3	28.9	28.8	29.4	29.9
Variations with the observer position at spacings:										
S = 1.0H	+ 0.1 / - 0.2					+ 0.1 / - 0.2				
1.5H	+ 0.2 / - 0.3					+ 0.2 / - 0.4				
2.0H	+ 0.1 / - 0.3					+ 0.2 / - 0.5				

CIE Pub.117, 20317 lm Total Lamp Luminous Flux Corrected (8log(F/F0) = 10.5)

C Range: 0 - 360DEG	γ Range: 0 - 180DEG
C Interval: 30.0DEG	γ Interval: 1.0DEG
Test Speed: HIGH	Test System:EVERFINE GO-2000B_V1 SYSTEM V2.0.404.7
Temperature:25.3DEG	Humidity:65.0%
Operators:H	Test Distance:4.430m [K=1.0000]
Test Date:2025-07-24	Remarks:

**UTILIZATION FACTORS TABLE**

Test:U:219.37V I:0.8197A P:176.03W PF:0.9789 Freq:50.00Hz Lamp Flux:22915.59x1 lm		
NAME: LSLH-175W	TYPE:	WEIGHT:
SPEC.:	DIM.:	SERIAL No.: LSLH-170W
MFR.: LSLH	SUR.:	Shielding Angle:

REFLECTANCE										
Ceiling	0.8	0.8	0.8	0.7	0.7	0.7	0.5	0.5	0.5	0
Walls	0.7	0.5	0.3	0.7	0.5	0.3	0.7	0.5	0.3	0
Working plane	0.2	0.2	0.2	0.2	0.2	0.2	0.2	0.2	0.2	0
ROOM INDEX	UTILIZATION FACTORS (PERCENT) $k(RI) \times RCR = 5$									
k = 0.60	57	45	38	56	45	38	55	44	38	31
0.80	67	55	48	66	55	48	64	54	47	40
1.00	75	64	57	74	63	56	72	65	56	49
1.25	82	72	65	81	71	64	78	69	63	56
1.50	87	77	70	86	76	70	82	75	69	61
2.00	94	86	79	92	84	78	89	82	77	68
2.50	98	90	84	96	89	83	92	86	81	73
3.00	102	95	89	99	93	88	95	90	85	77
4.00	106	100	95	103	98	94	99	94	91	81
5.00	108	103	99	105	101	97	101	97	94	84
ROOM INDEX	UF(total)									Direct
According to DIN EN 13032-2 2004			Suspended				SHRNOM = 1.25			

C Range: 0 - 360DEG  
C Interval: 30.0DEG  
Test Speed: HIGH  
Temperature: 25.3DEG  
Operators: H  
Test Date: 2025-07-24

$\gamma$  Range: 0 - 180DEG  
 $\gamma$  Interval: 1.0DEG  
Test System: EVERFINE GO-2000B\_V1 SYSTEM V2.0.404.7  
Humidity: 65.0%  
Test Distance: 4.430m [K=1.0000]  
Remarks:

**ISOCANDELA DIAGRAM**

Test:U:219.37V I:0.8197A P:176.03W PF:0.9789 Freq:50.00Hz Lamp Flux:22915.59x1 lm		
NAME: LSLH-175W	TYPE:	WEIGHT:
SPEC.:	DIM.:	SERIAL No.:LSLH-170W
MFR.: LSLH	SUR.:	Shielding Angle:

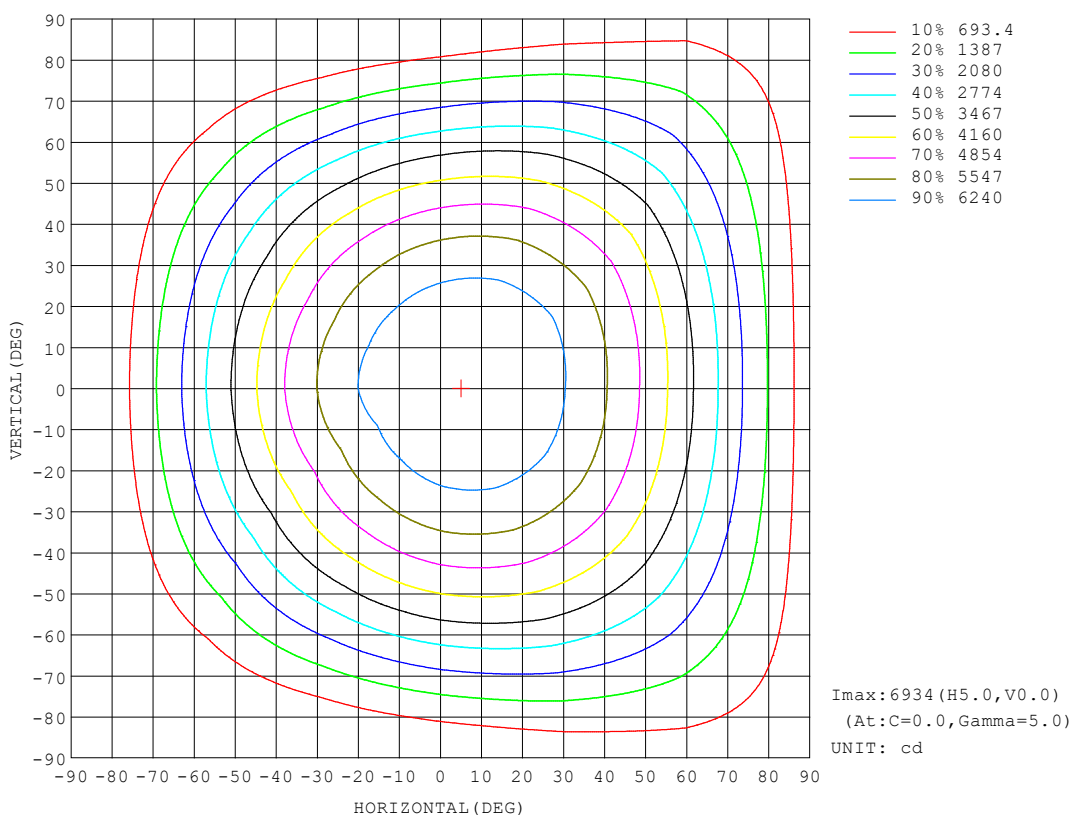

C Range: 0 - 360DEG  
 C Interval: 30.0DEG  
 Test Speed: HIGH  
 Temperature:25.3DEG  
 Operators:H  
 Test Date:2025-07-24

γ Range: 0 - 180DEG  
 γ Interval: 1.0DEG  
 Test System:EVERFINE GO-2000B\_V1 SYSTEM V2.0.404.7  
 Humidity:65.0%  
 Test Distance:4.430m [K=1.0000]  
 Remarks:

**AAI Figure**

Test:U:219.37V I:0.8197A P:176.03W PF:0.9789 Freq:50.00Hz Lamp Flux:22915.59x1 lm		
NAME: LSLH-175W	TYPE:	WEIGHT:
SPEC.:	DIM.:	SERIAL No.:LSLH-170W
MFR.: LSLH	SUR.:	Shielding Angle:

Flux out:14792 lm

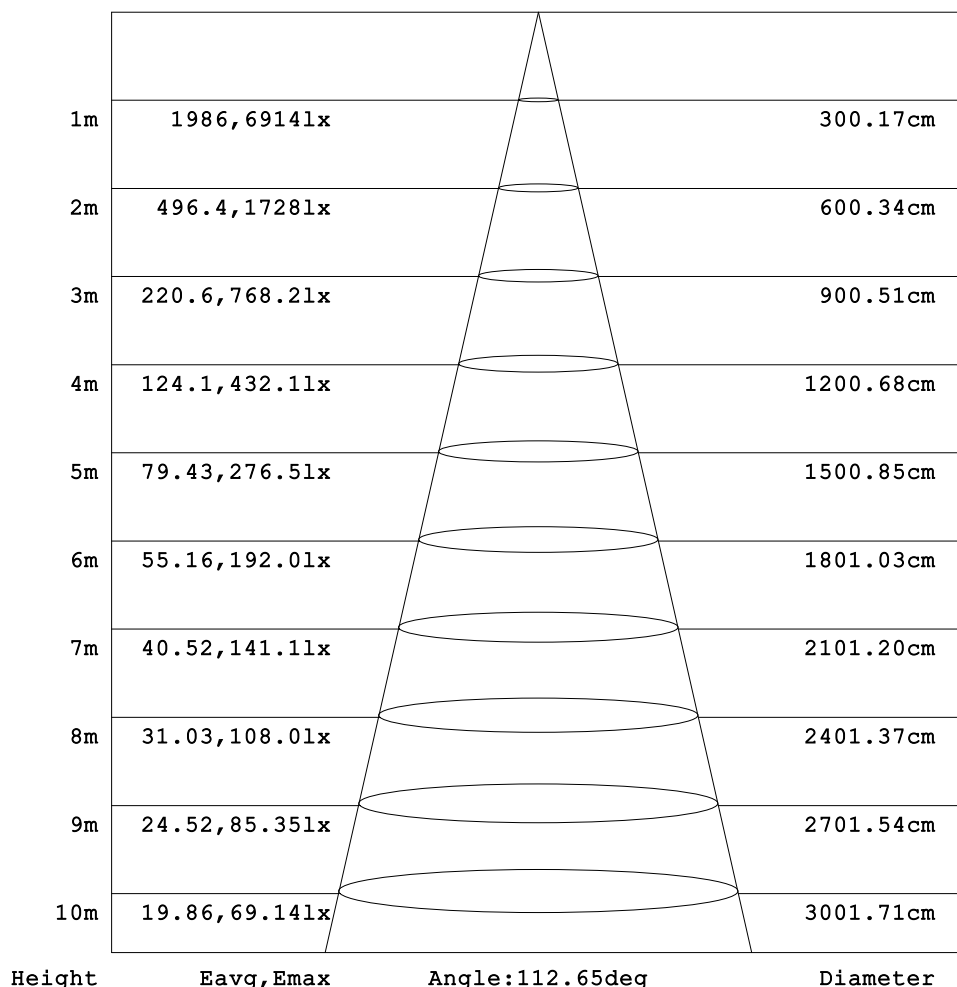

Note:The Curves indicate the illuminated area and the average illumination when the luminaire is at different distance.

C Range: 0 - 360DEG  
C Interval: 30.0DEG  
Test Speed: HIGH  
Temperature:25.3DEG  
Operators:H  
Test Date:2025-07-24

γ Range: 0 - 180DEG  
γ Interval: 1.0DEG  
Test System:EVERFINE GO-2000B\_V1 SYSTEM V2.0.404.7  
Humidity:65.0%  
Test Distance:4.430m [K=1.0000]  
Remarks:

**ISOLUX DIAGRAM**

Test:U:219.37V I:0.8197A P:176.03W PF:0.9789 Freq:50.00Hz Lamp Flux:22915.59x1 lm		
NAME: LSLH-175W	TYPE:	WEIGHT:
SPEC.:	DIM.:	SERIAL No.:LSLH-170W
MFR.: LSLH	SUR.:	Shielding Angle:

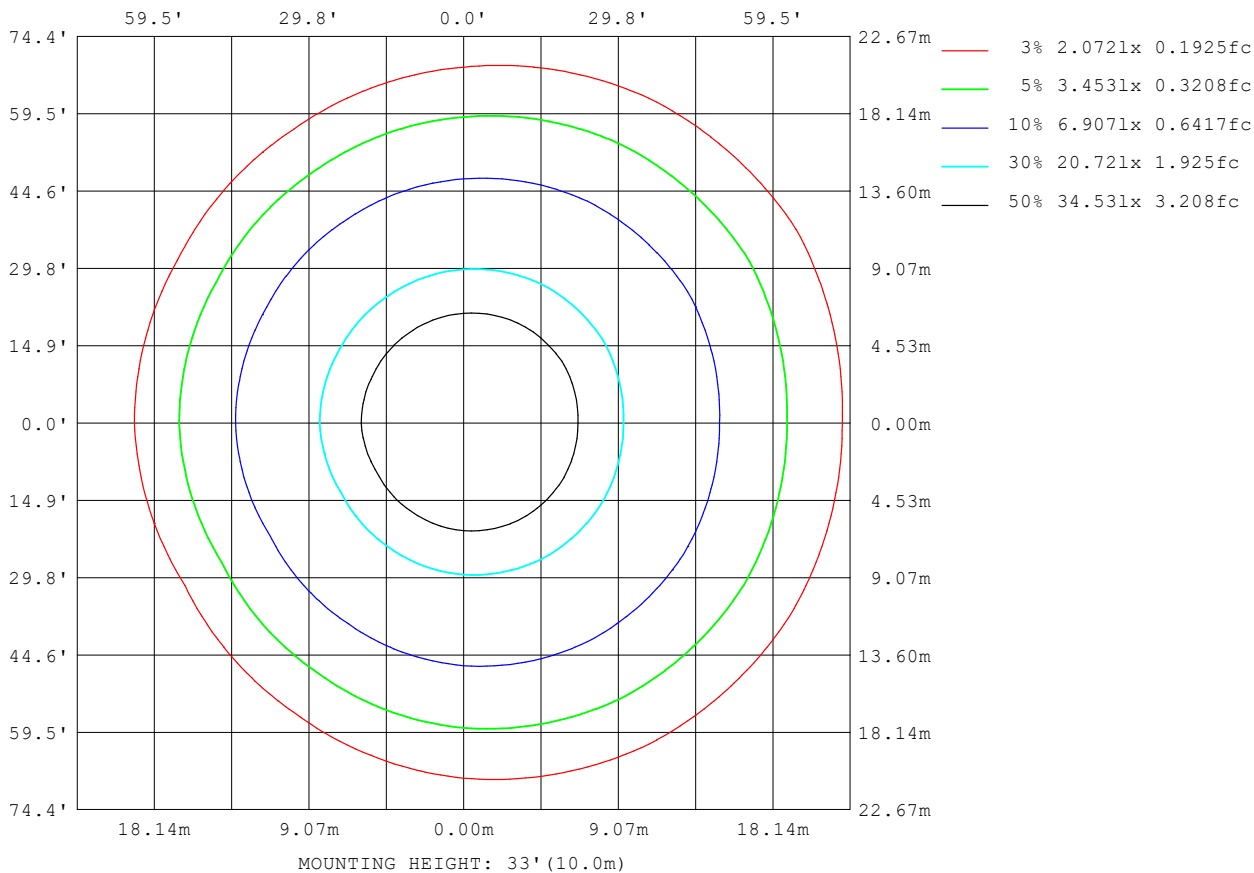

C Range: 0 - 360DEG  
 C Interval: 30.0DEG  
 Test Speed: HIGH  
 Temperature:25.3DEG  
 Operators:H  
 Test Date:2025-07-24

γ Range: 0 - 180DEG  
 γ Interval: 1.0DEG  
 Test System:EVERFINE GO-2000B\_V1 SYSTEM V2.0.404.7  
 Humidity:65.0%  
 Test Distance:4.430m [K=1.0000]  
 Remarks:

**LED Avg.L Report**

Test:U:219.37V I:0.8197A P:176.03W PF:0.9789 Freq:50.00Hz Lamp Flux:22915.59x1 lm		
NAME: LSLH-175W	TYPE:	WEIGHT:
SPEC.:	DIM.:	SERIAL No.: LSLH-170W
MFR.: LSLH	SUR.:	Shielding Angle:

AvgL	cd/m2
L_0~180 (65) av	16363
L_0~180 (75) av	14563
L_0~180 (85) av	13405
L_90~270 (65) av	16479
L_90~270 (75) av	14360
L_90~270 (85) av	9698
L_45 (65) av	16437
L_45 (75) av	14563
L_45 (85) av	12922

Standard: GB/T 29293-2012

C Range: 0 - 360DEG  
 C Interval: 30.0DEG  
 Test Speed: HIGH  
 Temperature:25.3DEG  
 Operators:H  
 Test Date:2025-07-24

γ Range: 0 - 180DEG  
 γ Interval: 1.0DEG  
 Test System:EVERFINE GO-2000B\_V1 SYSTEM V2.0.404.7  
 Humidity:65.0%  
 Test Distance:4.430m [K=1.0000]  
 Remarks:

**Planar Illuminance Curve**

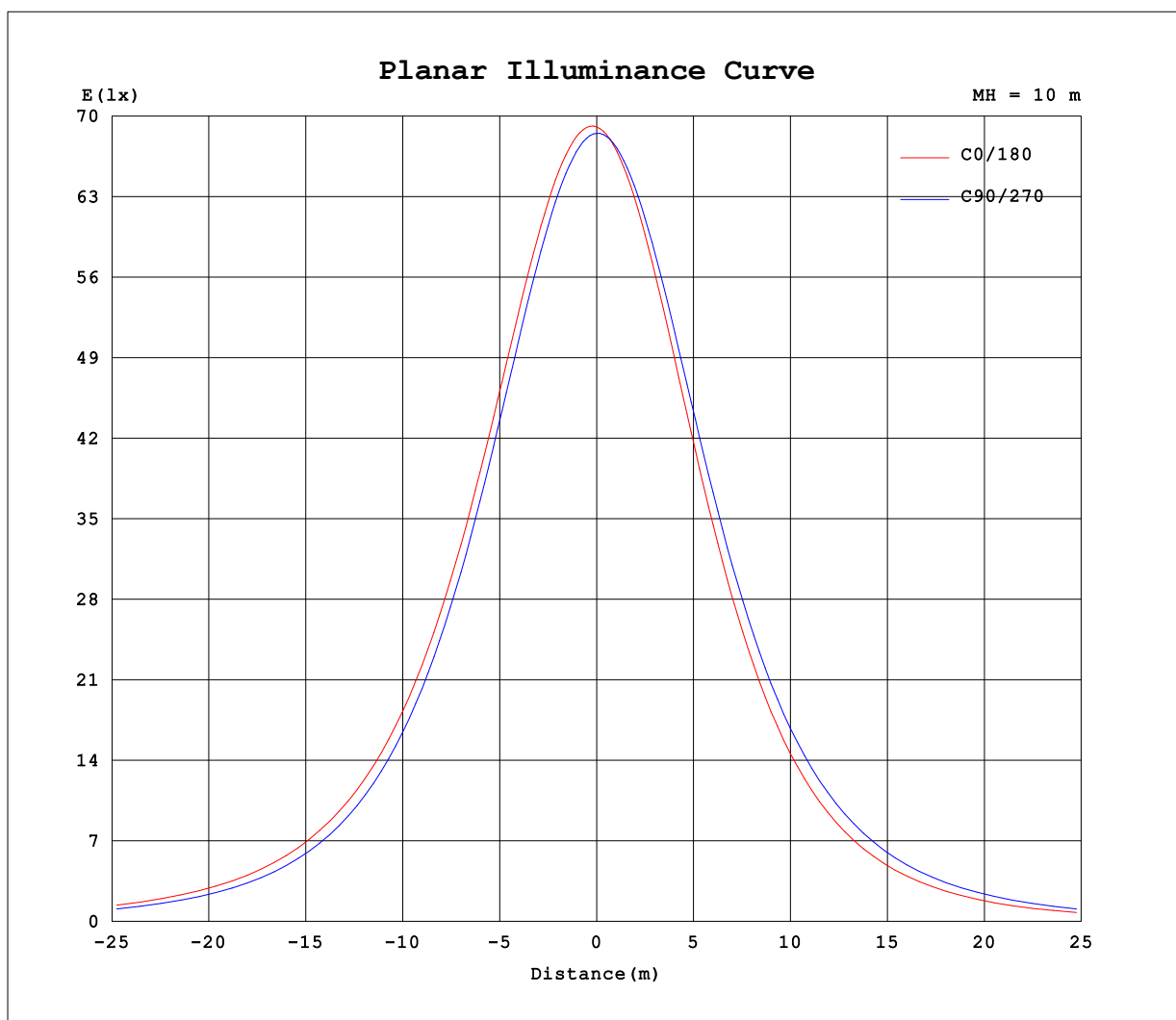

C Range: 0 - 360DEG  
 C Interval: 30.0DEG  
 Test Speed: HIGH  
 Temperature: 25.3DEG  
 Operators: H  
 Test Date: 2025-07-24

γ Range: 0 - 180DEG  
 γ Interval: 1.0DEG  
 Test System: EVERFINE GO-2000B\_V1 SYSTEM V2.0.404.7  
 Humidity: 65.0%  
 Test Distance: 4.430m [K=1.0000]  
 Remarks:

**LUMINOUS DISTRIBUTION INTENSITY DATA**

Test:U:219.37V I:0.8197A P:176.03W PF:0.9789 Freq:50.00Hz Lamp Flux:22915.59x1 lm		
NAME: LSLH-175W	TYPE:	WEIGHT:
SPEC.:	DIM.:	SERIAL No.:LSLH-170W
MFR.: LSLH	SUR.:	Shielding Angle:

Table--1

UNIT: cd

C (DEG) \ γ (DEG)	0	30	60	90	120	150	180	210	240	270	300	330						
0	6907	6890	6867	6852	6845	6849	6907	6890	6867	6852	6845	6849						
5	6934	6911	6865	6814	6767	6748	6826	6816	6820	6841	6873	6898						
10	6908	6882	6814	6729	6639	6592	6690	6687	6720	6781	6852	6896						
15	6829	6801	6715	6594	6459	6380	6496	6500	6565	6668	6779	6841						
20	6697	6669	6565	6409	6226	6112	6243	6254	6354	6501	6653	6734						
25	6509	6482	6362	6170	5937	5784	5931	5947	6082	6275	6471	6571						
30	6264	6239	6103	5874	5592	5401	5557	5578	5746	5987	6228	6349						
35	5957	5939	5787	5523	5190	4966	5129	5152	5350	5634	5922	6066						
40	5595	5580	5415	5116	4740	4483	4651	4675	4897	5221	5553	5722						
45	5178	5169	4990	4660	4246	3965	4131	4153	4393	4751	5124	5320						
50	4708	4706	4514	4159	3714	3416	3581	3600	3849	4233	4641	4865						
55	4197	4199	3999	3621	3158	2848	3012	3024	3276	3676	4113	4361						
60	3651	3657	3449	3058	2585	2273	2432	2437	2685	3091	3547	3818						
65	3080	3091	2876	2480	2009	1705	1856	1854	2090	2491	2959	3246						
70	2500	2512	2296	1902	1446	1159	1298	1287	1508	1894	2359	2659						
75	1920	1933	1719	1338	911	644	770	754	956	1315	1766	2070						
80	1351	1368	1161	807	419	181	285	268	443	770	1194	1490						
85	814	831	640	326	48.3	20.6	19.8	21.1	21.6	277	658	937						
90	322	338	178	20.3	22.2	23.5	22.5	23.9	22.7	21.0	176	428						
95	19.3	20.0	21.0	22.6	25.3	27.0	26.2	27.4	25.6	23.2	21.5	44.1						
100	21.8	22.4	23.6	25.8	28.7	30.7	30.0	31.1	28.9	26.2	23.8	22.6						
105	25.5	26.0	26.9	29.6	32.4	34.4	33.9	34.8	32.5	29.7	26.9	25.9						
110	30.6	30.9	31.6	34.2	37.3	39.3	38.5	39.5	36.9	34.0	31.3	30.4						
115	36.4	36.5	37.1	39.5	43.0	45.0	43.6	44.7	42.0	38.6	36.1	35.4						
120	41.3	41.3	41.7	43.9	47.3	50.0	48.3	49.5	46.4	42.9	40.7	39.9						
125	45.7	45.6	46.0	47.4	50.8	54.7	51.8	53.1	49.2	45.7	44.1	43.2						
130	49.4	49.1	49.5	50.5	53.8	58.1	55.1	56.3	51.6	48.2	47.0	46.2						
135	52.3	52.1	52.2	53.0	56.0	60.2	57.6	58.4	53.8	50.6	49.5	49.0						
140	55.1	55.4	55.0	55.5	58.2	61.0	59.6	59.9	55.9	53.0	52.2	52.1						
145	57.9	58.3	58.0	58.0	60.5	62.5	61.9	60.0	58.3	55.5	55.0	55.1						
150	60.5	61.4	61.2	60.8	63.1	61.8	64.5	61.4	60.7	58.2	58.0	58.0						
155	63.4	64.8	64.5	63.9	65.4	63.7	67.2	61.9	63.4	61.3	61.1	61.2						
160	66.0	68.5	67.5	65.9	67.5	69.1	70.3	67.0	66.1	64.0	64.4	64.9						
165	69.0	72.1	69.8	67.6	69.2	71.5	73.9	71.9	68.7	66.2	67.1	68.7						
170	71.5	74.1	70.6	68.6	69.9	72.9	76.4	73.6	70.5	68.0	68.8	71.6						
175	71.4	71.3	67.5	66.1	66.8	70.2	74.0	72.1	68.9	66.9	67.4	70.6						
180	67.9	66.9	63.4	62.1	62.4	65.5	67.9	66.9	63.5	62.1	62.4	65.5						

C Range: 0 - 360DEG  
C Interval: 30.0DEG  
Test Speed: HIGH  
Temperature:25.3DEG  
Operators:H  
Test Date:2025-07-24

γ Range: 0 - 180DEG  
γ Interval: 1.0DEG  
Test System:EVERFINE GO-2000B\_V1 SYSTEM V2.0.404.7  
Humidity:65.0%  
Test Distance:4.430m [K=1.0000]  
Remarks:



# Casambi Smart Luminaire Operation Demo

<https://casambi.com>

<https://casambi.com/news/casambi-tutorial-videos/>

**CASAMBI**

## Casambi App overview



Energy Saving  
**SkyRaft**

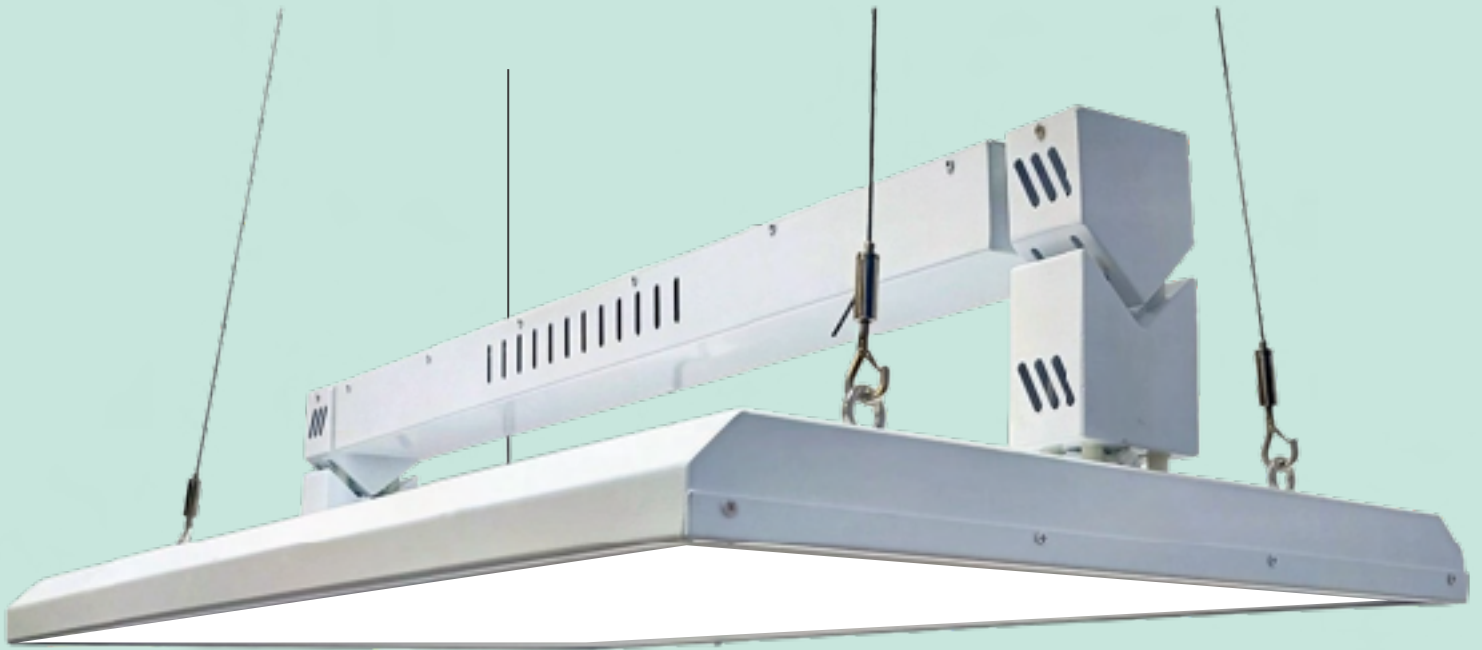

**The best for the most with the least**  
Ray Eames

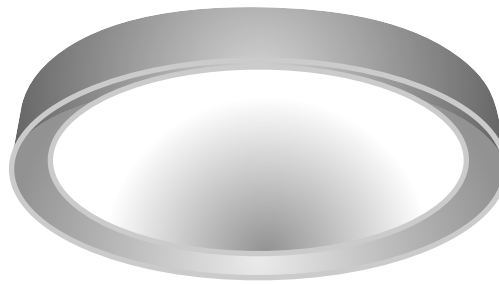
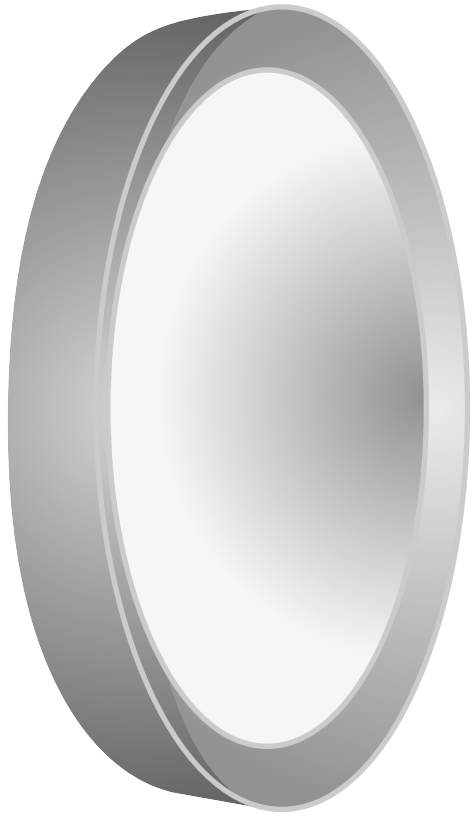

# OPTIM•AL



**Guarantee**

**Energy**

**Product Code**

OPDREFE2400N34565UKEU  
OPDREFE2400N34565MSUKEU  
OPDREFE2400N34565EMUKEU  
OPDREFE2400N34565EMMSUKEU

## DREADNOUGHT Series

**3 sizes, microsensor, dimmable, DALI, EM**

### Uses

Airports  
Railway stations  
Sports stadiums  
commercial  
and residential  
installations

### Certifications

UKCA CE TUV VDE  
RoHS UL CUL  
IP 67, IK 10, EN 62262  
Trademark **OPTIM•AL**  
Design copyright  
Studio FPM  
Energy Label **C**

### Specifications

**Guarantee** 10 years warranted and insured by Lloyd's of London

**Material** Die cast in 'thin wall' stainless steel 304

**Lumens** 3000-5000-8000k

**Watts** 20, 30 or 50

**CCT** 3/4/5/6K switchable

**CRI** 80

**Driver** Inventronic 10 year guarantee, dim, MS, EM version, 3 hour 20% output 3-year life. Li-ion batteries 1 for 30 cm, 2 for 50 cm and 3 for 80 cm diameter

**Projection** 50, 60, 80mm

**Surface** Ceiling or Wall

**Lens** Super tough convex Gorilla glass

**Dimensions** 30, 50, 80 cm diameter



# OPTIM•AL



**Guarantee**

**Energy**

**Product Code**

OPDREFE2400N34565UKEU  
OPDREFE2400N34565MSUKEU  
OPDREFE2400N34565EMUKEU  
OPDREFE2400N34565EMMSUKEU

## DREADNOUGHT Bulkhead Full

### Batteries

**3 year rating**  
**3 year performance**

### Uses

Airports  
Railway stations  
Sports stadiums  
commercial  
and residential  
installations

### Certifications

UKCA CE TUV SELV  
RoHS UL Recolight  
IP 67/IK 10  
Trademark **OPTIM•AL**  
Design copyright  
Studio FPM  
Energy Label **E**

### Specifications

**Guarantee** 10 years warranted and insured by Lloyd's of London

**Material** Die cast in 'thin wall' stainless steel 304

**Lumens** 2400

**Watts** 20

**CCT** 3/4/5/6K switchable

**CRI** 80

**Driver** PF90

**Types** On-off; plus micro-wave sensor; or emergency 3 hour Lithium Ion batteries; battery life rating 3 years

**Surface** Ceiling or Wall

**Lens** Super tough convex Gorilla glass

**Dimensions** 350mm dia x 107mm

**Service Life** 60000 hours

# OPTIM•AL



Guarantee

Energy

Product Code

OPDREHE240020N34565UKEU  
OPDREHE240020N34565MSUKEU  
OPDREHE240020N34565EMUKEU  
OPDREHE240020N34565EMMSUKEU

## DREADNOUGHT Bulkhead Half

### Batteries

3 year rating  
3 year performance

### Uses

Airports  
Railway stations  
Sports stadiums  
commercial  
and residential  
installations

### Certifications

UKCA CE TUV SELV  
RoHS UL Recolight  
IP 67/IK 10  
Trademark **OPTIM•AL**  
Design copyright  
Studio FPM  
Energy Label **E**

### Specifications

**Guarantee** 10 years warranted and insured by Lloyd's of London

**Material** Die cast in 'thin wall' stainless steel 304

**Lumens** 2400

**Watts** 20, lumens/watt 120

**CCT** 3/4/5/6K switchable

**CRI** 80

**Driver** PF90

**Types** On-off; plus micro-wave sensor; or emergency 3 hour Lithium Ion batteries; battery life rating 3 years

**Surface** Ceiling or Wall

**Lens** Super tough convex Gorilla glass

**Dimensions** 350mm dia x 107mm

**Service Life** 60000 hours

# Energy Saving Projector



# OPTIM•AL



Guarantee



Energy

Product Code

OPPROTRACC24003N159003UKEU  
OPPROTRACC24003N159004UKEU  
OPPROTRACC24003N15POLUKEU

## FIXED BEAM Track 15°

Allom Cool Head  
Technology™

### Uses

Retail  
Museums  
Showrooms

### Certifications

VDE TUV CE Rohs  
Recolight NEMCO UL  
CUL UKCA  
ISO 9001, ISO 14001,  
SEDEX, SMETA  
IP 54  
Patented UK/EU/USA  
Trademark **OPTIM•AL**  
Design copyright  
Studio FPM  
Energy Label **C**

### Specifications

**Guarantee** 10 years warranted and insured by Lloyd's of London

**Material** Powder painted aluminium or polished and natural anodized  
Aluminium White RAL 9003 and Black RAL 9004

**Lumens** 2400

**Watts** 15 watts, 230 volts

**Lumens/Watt** 160 lumens/watt

**CCT** 3000K with 2-Step MacAdam

**CRI** 90

**Driver** Tridonic, PF 97 Non dimmable, 97-277v

**Beam Angle** 15 degrees, super optic lenses

**Dimensions** 180mm long, 90mm dia.

**Euro track** 3 channels, 1 or 2 metres

**Service Life** 60000 hours/10 years

Energy Saving  
**Projector**



**OPTIM•AL**



**Guarantee**

**Energy**

**Product Code**

OPPROTRACC24003N249003UKEU  
OPPROTRACC24003N249004UKEU  
OPPROTRACC24003N24POLUKEU

**FIXED BEAM  
Track 24°**

**Allom Cool Head  
Technology™**

**Uses**

Retail  
Museums  
Showrooms

**Certifications**

VDE TUV CE Rohs  
Recolight NEMCO UL  
CUL UKCA  
ISO 9001, ISO 14001,  
SEDEX, SMETA  
IP 54  
Patented UK/EU/USA  
Trademark **OPTIM•AL**  
Design copyright  
Studio FPM  
Energy Label **C**

**Specifications**

**Guarantee** 10 years warranted and insured by Lloyd's of London

**Material** Powder painted aluminium or polished and natural anodized  
Aluminium White RAL 9003 and Black RAL 9004

**Lumens** 2400

**Watts** 15 watts, 230 volts

**Lumens/Watt** 160 lumens/watt

**CCT** 3000K with 2-Step MacAdam

**CRI** 90

**Driver** Tridonic, PF 97 Non dimmable, 97-277v

**Beam Angle** 24 degrees, super optic lenses

**Dimensions** 180mm long, 90mm dia.

**Euro track** 3 channels, 1 or 2 metres

**Service Life** 60000 hours/10 years

# Energy Saving Projector



# OPTIM•AL



Guarantee



Energy

Product Code

OPPROTRACC24003N369003UKEU  
OPPROTRACC24003N369004UKEU  
OPPROTRACC24003N36POLUKEU

## FIXED BEAM Track 36°

Allom Cool Head  
Technology™

### Uses

Retail  
Museums  
Showrooms

### Certifications

VDE TUV CE Rohs  
Recolight NEMCO UL  
CUL UKCA  
ISO 9001, ISO 14001,  
SEDEX, SMETA  
IP 54  
Patented UK/EU/USA  
Trademark **OPTIM•AL**  
Design copyright  
Studio FPM  
Energy Label **C**

### Specifications

**Guarantee** 10 years warranted and insured by Lloyd's of London

**Material** Powder painted aluminium or polished and natural anodized  
Aluminium White RAL 9003 and Black RAL 9004

**Lumens** 2400

**Watts** 15 watts, 230 volts

**Lumens/Watt** 160 lumens/watt

**CCT** 3000K with 2-Step MacAdam

**CRI** 90

**Driver** Tridonic, PF 97 Non dimmable, 97-277v

**Beam Angle** 36 degrees, super optic lenses

**Dimensions** 180mm long, 90mm dia.

**Euro track** 3 channels, 1 or 2 metres

**Service Life** 60000 hours/10 years

Energy Saving  
**Projector**



**OPTIM•AL**



**Guarantee**



**Energy**

**Product Code**

OPPPROCCL24003N159003UKEU  
OPPPROCCL24003N159004UKEU  
OPPPROCCL24003N15POLUKEU

**FIXED BEAM**  
**Ceiling plate 15°**

**Allom Cool Head  
Technology™**

**Uses**

Retail  
Museums  
Showrooms

**Certifications**

VDE TUV CE Rohs  
Recolight NEMCO UL  
CUL UKCA  
ISO 9001, ISO 14001,  
SEDEX, SMETA  
IP 54  
Patented UK/EU/USA  
Trademark **OPTIM•AL**  
Design copyright  
Studio FPM  
Energy Label **C**

**Specifications**

**Guarantee** 10 years warranted and insured by Lloyd's of London

**Material** Powder painted aluminium or polished and natural anodized  
Aluminium White RAL 9003 and Black RAL 9004

**Lumens** 2400

**Watts** 15 watts, 230 volts

**Lumens/Watt** 160 lumens/watt

**CCT** 3000K with 2-Step MacAdam

**CRI** 90

**Driver** Tridonic, PF 97 Non dimmable, 97-277v

**Beam Angle** 15 degrees, super optic lenses

**Dimensions** 180mm long, 90mm dia. Ceiling plate 120mm dia.,  
with rapid 3 pole connector Cut out 100mm dia.

**Service Life** 60000 hours/10 years

Energy Saving  
**Projector**



**OPTIM•AL**



**Guarantee**

**Energy**

**Product Code**

OPPPROCCL24003N249003UKEU  
OPPPROCCL24003N249004UKEU  
OPPPROCCL24003N24POLUKEU

**FIXED BEAM**  
**Ceiling plate 24°**

**Allom Cool Head  
Technology™**

**Uses**

Retail  
Museums  
Showrooms

**Certifications**

VDE TUV CE Rohs  
Recolight NEMCO UL  
CUL UKCA  
ISO 9001, ISO 14001,  
SEDEX, SMETA  
IP 54  
Patented UK/EU/USA  
Trademark **OPTIM•AL**  
Design copyright  
Studio FPM  
Energy Label **C**

**Specifications**

**Guarantee** 10 years warranted and insured by Lloyd's of London

**Material** Powder painted aluminium or polished and natural anodized  
Aluminium White RAL 9003 and Black RAL 9004

**Lumens** 2400

**Watts** 15 watts, 230 volts

**Lumens/Watt** 160 lumens/watt

**CCT** 3000K with 2-Step MacAdam

**CRI** 90

**Driver** Tridonic, PF 97 Non dimmable, 97-277v

**Beam Angle** 24 degrees, super optic lenses

**Dimensions** 180mm long, 90mm dia. Ceiling plate 120mm dia.,  
with rapid 3 pole connector Cut out 100mm dia.

**Service Life** 60000 hours/10 years

Energy Saving  
**Projector**



**OPTIM•AL**



**Guarantee**

**Energy**

**Product Code**

OPPPROCCL24003N369003UKEU  
OPPPROCCL24003N369004UKEU  
OPPPROCCL24003N36POLUKEU

**FIXED BEAM**  
**Ceiling plate 36°**

**Allom Cool Head  
Technology™**

**Uses**

Retail  
Museums  
Showrooms

**Certifications**

VDE TUV CE Rohs  
Recolight NEMCO UL  
CUL UKCA  
ISO 9001, ISO 14001,  
SEDEX, SMETA  
IP 54  
Patented UK/EU/USA  
Trademark **OPTIM•AL**  
Design copyright  
Studio FPM  
Energy Label **C**

**Specifications**

**Guarantee** 10 years warranted and insured by Lloyd's of London

**Material** Powder painted aluminium or polished and natural anodized  
Aluminium White RAL 9003 and Black RAL 9004

**Lumens** 2400

**Watts** 15 watts, 230 volts

**Lumens/Watt** 160 lumens/watt

**CCT** 3000K with 2-Step MacAdam

**CRI** 90

**Driver** Tridonic, PF 97 Non dimmable, 97-277v

**Beam Angle** 36 degrees, super optic lenses

**Dimensions** 180mm long, 90mm dia. Ceiling plate 120mm dia.,  
with rapid 3 pole connector Cut out 100mm dia.

**Service Life** 60000 hours/10 years



Photography: Elizabeth Brown

Photographed at Woolsthorpe Manor, the birthplace of Sir Isaac Newton with the actual tree in the background courtesy of the National Trust.

### Isaac Newton (1643 - 1727)



Newton was an English physicist and mathematician and the greatest scientist of his era.

Isaac Newton was born on 4 January 1643 at Woolsthorpe Manor, Lincolnshire. In 1661, he went to Cambridge University where he became interested in mathematics, optics, physics and astronomy. In October 1665 a plague epidemic forced the university to close and Newton returned to Woolsthorpe Manor. The two years he spent there were an extremely productive time during which he began to think about gravity, and also devoted time to optics and mathematics.

In 1667 Newton returned to Cambridge, where he became a Fellow of Trinity College. It was Newton's reflecting telescope, made in 1668, that finally brought him to the attention of the scientific community and in 1672 he was made a Fellow of the Royal Society. From the mid 1660's Newton conducted a series of experiments on the composition of light, discovering that white light is composed of the same system of colours that can be seen in a rainbow and establishing the modern study of optics. In 1704 Newton published 'The Opticks' which dealt with light and colour.

However, in 1687, with the help of the astronomer Edmond Halley, Newton published his single greatest work, the 'Philosophiae Naturalis Principia Mathematica' ('Mathematical Principles of Natural Philosophy'). This showed how a universal force, gravity, applied to all objects in all parts of the universe.

In 1703 he was elected President of the Royal Society, an office he held until his death. He died on 31 March 1727 and was buried in Westminster Abbey. He was 84 years old.



# Newton

# OPTIM•AL



Guarantee

Energy

Product Code

OPNEWT804B11103D60UKEU

## NEWTON 804

Allom Cool Head  
Technology™

### Uses

Retail  
Museums  
Showrooms

### Certifications

UKCA UL CE  
VDE TUV  
Patented  
UK/EU/USA  
Design copyright  
Giancarlo Fassina  
Carlo Forcolini  
Studio FPM  
Energy Label C  
Trademark  
OPTIM•AL

### Specifications

**Guarantee** 10 years warranted and insured by Lloyd's of London

**Material** Hand polished top grade Australian aircraft aluminium  
head clear lacquered and base plated, arms anodised

**Lumens** 1280

**Watts** 8 watts

**Lumens/Watt** 160 lumens/watt

**CCT** 3000K

**CRI** 90

**Driver** 10 Watt Universal Driver 97-277v dimmable

**Beam Angle** 7 x (2 x 30°) TIR reflectors (60°) super reflective

**Dimensions** Arms both 360mm

**Service Life** 60000 hours/10 years

# Newton

# OPTIM•AL



**10**  
Year



Guarantee

Energy

Product Code

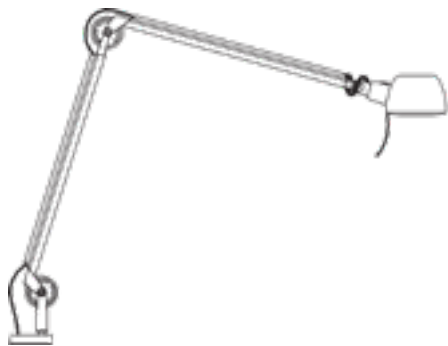

**804 36 in**  
mini desk top  
£ 355  
OPNEWT804IN36B11103D60UKEU

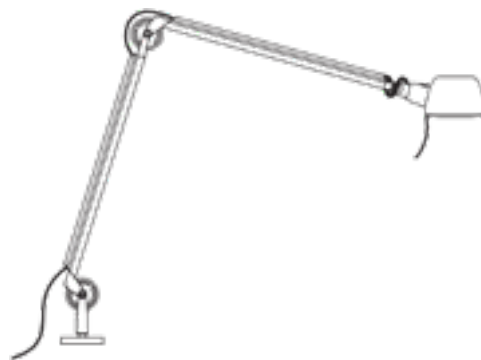

**804 36 out**  
mini desk top  
£ 355  
OPNEWT804OUT36B11103D60UKEU



**805 46 in**  
desk top  
£ 375  
OPNEWT805IN46B11103D60UKEU

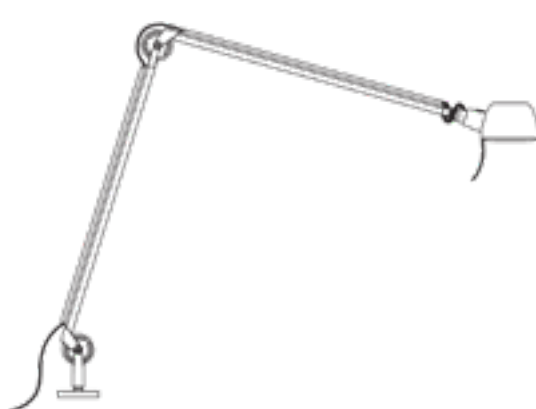

**805 46 out**  
desk top  
£ 375  
OPNEWT805OUT46B11103D60UKEU

# Newton

# OPTIM•AL



**10**  
Year



Guarantee

Energy

Product Code

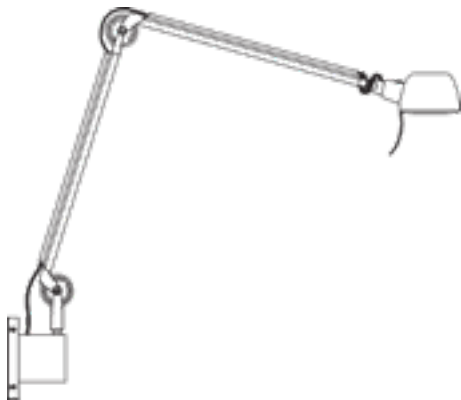

**803 36 in**  
wall two arm  
£ 365  
OPNEWT803IN36B11103D60UKEU

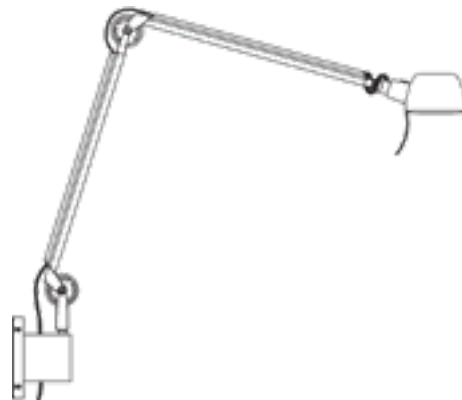

**803 36 out**  
wall two arm  
£ 365  
OPNEWT803OUT36B11103D60UKEU

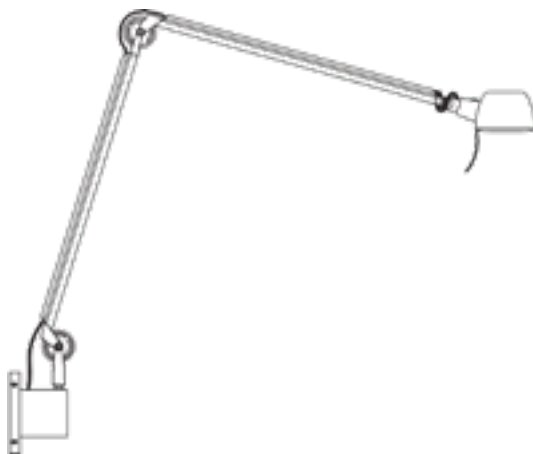

**803 46 in**  
wall two arm  
£ 395  
OPNEWT803IN46B11103D60UKEU

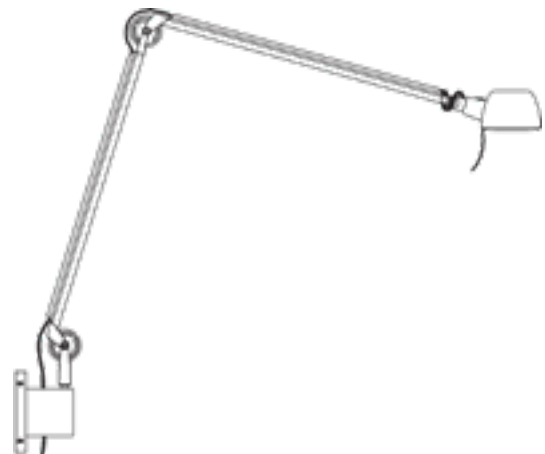

**803 46 out**  
wall two arm  
£ 395  
OPNEWT803OUT46B11103D60UKEU

# Newton

# OPTIM•AL



Guarantee



Energy

Product Code

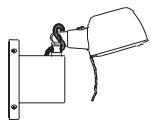

**800 in**  
wall  
£ 295  
OPNEWT800INB11103D60UKEU

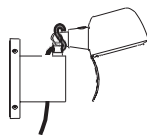

**800 out**  
wall  
£ 295  
OPNEWT800OUTB11103D60UKEU

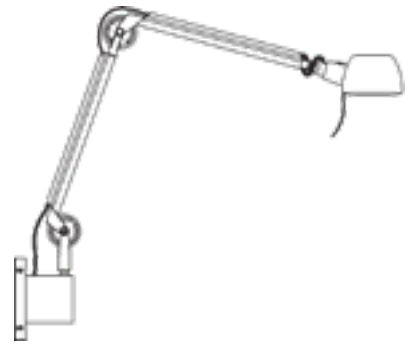

**802 25 in**  
two arm  
£ 345  
OPNEWT802INB11103D60UKEU

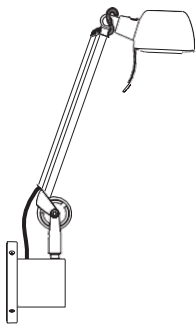

**801 in**  
wall one arm  
£ 325  
OPNEWT801INB11103D60UKEU

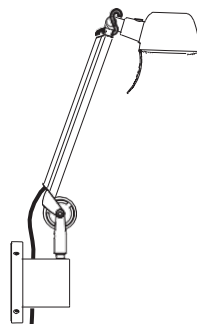

**801 out**  
wall one arm  
£ 325  
OPNEWT801OUTB11103D60UKEU

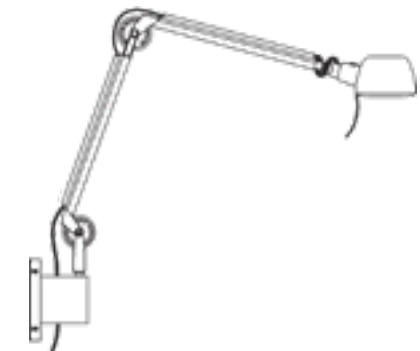

**802 25 out**  
wall two arm  
£ 345  
OPNEWT802OUTB11103D60UKEU

# Newton

# OPTIM•AL



Guarantee

Energy

Product Code

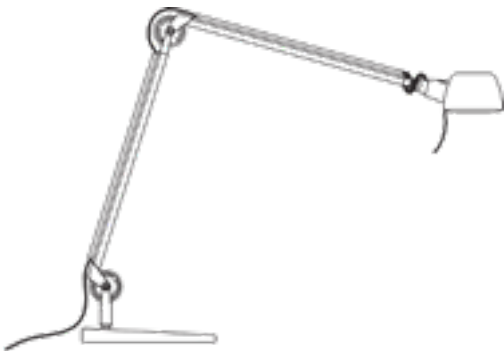

**804 36**

Mini table

£ 395

OPNEWT804B11103D60UK

OPNEWT804B11103D60EU



**805 46**

Table

£ 425

OPNEWT805B11103D60UK

OPNEWT805B11103D60EU



**806 100 46**

Floor

£ 495

OPNEWT806B11103D60UK

OPNEWT806B11103D60EU

**EVCP.**





**Guarantee**

- 2 x 22kw, 2 x 55kw and 2 x 110kw AC 3 phase twin sockets and card readers
- RFID card/fob via OCCP management systems
- IP67 all weathers
- IK10 very robust structure with black nylon dampening seals and black nylon ribbon strips to all edges to dampen vibration
- 8 year guarantee, insured and certificated by Lloyds of London
- BSI tested and certificated, UKAL, CE, VDE, TUV, (UL and CUL later if required)
- 1300mm high x 420mm wide and 270mm deep
- Two Stainless Steel 304 pressed top and ribbed base plates 3mm thick to connect to the NAL inground
- Stainless Steel 304 body with many cutouts and welds for NAL fixing with 2 x M10 hexagon head bolts meter, 1 x twin card reader and 2x Mennekes charging sockets.
- Access panel covers 650mm high and 300mm wide to cover hole 600mm high and 250mm wide with black nylon ribbon 1mm thick all round inside of panel cover, secured with 8 x M8 stainless steel 304 bolts coated in black oxide & TORX security socket heads.
- E/driver Pay-to-charge smartphone integration
- Built in AC overload protection
- On board RFID readers and GPRS modem with antenna and ethernet connections
- OCCP-6 compliant, can integrate with any back office and remote firmware updates
- Type 2 (IEC 62196) 3 phase sockets c/w security hatchlocks
- Smart App/RFID controlled Mode 3 (IEC 61851-1) fast charging
- Painted with titanium epoxy powder RAL 9004, other colours by arrangement, on top of silicon dioxide
- Total of 52 TORX socket head M8 bolts, complete assembly with free issue TORX head wrenches

**Charging Socket(s):** 2 x IEC 62196-2 (Type 2) with illumination

Rated system output:

- 3.6 kW (16A), 7.2 kW (32A), and 22 kW
- Standby power consumption < 7w per socket

**Input Voltage:** 400V AC/50Hz (Single phase)

Overload & Fault Current Protection:

- Built in AC overload & Fault current protection (RCBO)
- Built in 6mA DC leakage protection
- Lightning surge protection
- TruePEN PME fault detection
- Support for dynamic load balancing & static load management
- Over-air software update/monitoring,
- Over temperature protection.

**Street Connection:** 5 x 50mm 3P + N + E

Energy Monitoring:

- Built in class 1 MID compliant kWh meter,
- Built in time clock for charge time management.

**Charging Mode:** IEC 61851-1 Mode 3

User interfacing:

- Plug and Charge Mobile App & RFID controlled
- Contactless payment systems interface
- Integrated RFID & GUI system panel

**Communications:**

- 4G LTE Cat-1
- Wi-Fi
- Ethernet connectivity
- Bluetooth BLE 4.1
- Encryption level TLS 1.2
- Open source card readers

**Compliance:**

OCCP compliant

BS 7671:2018 - SECTION 722 compliant.

## Products - All with 10 year guarantee

<b>Series S</b>		<b>Series 30</b>	
S	Wall and ceiling light	31	Wall and ceiling light
FS	Single floor light	31T	Tronic wall and ceiling light
FS2	Twin floor light	31/50	Ceiling light
SS	Wall and ceiling light	31/2x50	Twin ceiling light
FSS	Single floor light	33/50	Single footlight
FSS2	Twin floor light	33/2x50	Twin footlight
<b>Series A</b>		<b>Series 40</b>	
A	Wall and ceiling light	41	Wall and ceiling light
A/SW	Switched wall light	41/2	Twin ceiling light
TA	Table light	41/4/1m	Four lamp ceiling light
FA	Single floor light	41/6/1.5m	Six lamp ceiling light
FA2	Twin floor light		
<b>Series 20</b>		<b>Series 200</b>	
21	Wall and ceiling light	201	Wall and ceiling light
21T	Tronic wall and ceiling light	201/SW	Switched wall light
21/50	Single ceiling light	201/2	Twin ceiling light
21/2x50	Twin ceiling light	201/3	Triple ceiling light
23/50	Single footlight	201/4	Four lamp ceiling light
23/2x50	Twin footlight	201/6/1.5m	Six lamp ceiling light
25/50	Table light	205	Table light
26/50	Floor light	206	Floor light
<b>Downlights</b>		<b>GU10</b>	
Downlight	IP20 Ceiling light	GU10	5 or 7 watt, dim or non dim
Downlight	IP65 Bathroom light	GU10	8.5, 1110 lumen, 63mm diameter



**S**

**Ceiling or wall light**

**Certifications**

UKCA, CE, RoHS,  
Recolight  
Design copyright  
Studio FPM  
Energy Label **F**  
Trademark **AL**

**Specifications**

**Guarantee** 10 years warranted and insured by Lloyd's of London

**Material** Hand polished top grade aircraft aluminium

**Lumens** 1275

**Watts** 15 watts

**Lumens/Watt** 85

**CCT** 3000K

**CRI** 80

**Beam Angle** 120

**Lamp** R95 LED

**Dimensions** 150mm projection

**Weight** 305 grams

**Design** Peter Nelson

## Series S

# AL

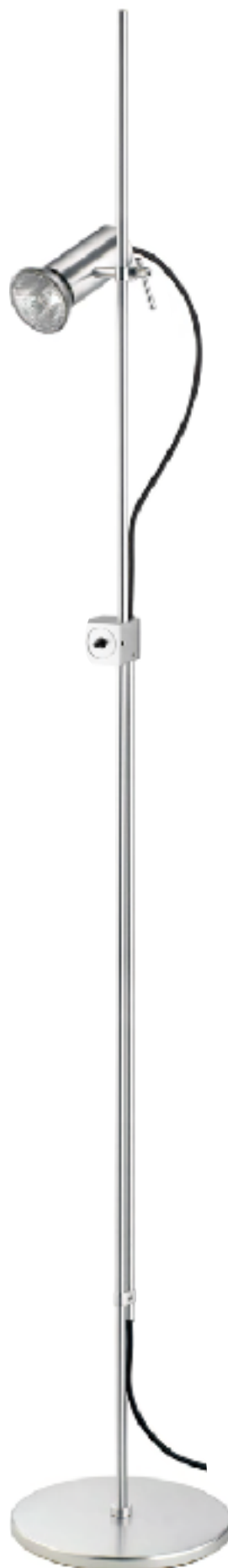

<b>FS</b>	<b>Single floor light</b>
<b>Guarantee</b>	10 years warranted and insured by Lloyd's of London
<b>Energy label</b>	F
<b>Lumens</b>	1275
<b>Watts</b>	15
<b>Lumen/Watts</b>	85
<b>Dimensions</b>	1390mm height
<b>Weight</b>	3700 grams
<b>Lamp</b>	R95 LED
<b>CCT</b>	3000K
<b>CRI</b>	80
<b>Beam angle</b>	120 degrees
<b>Certificate</b>	UKCA, CE, RoHS, Recolight
<b>Trade mark</b>	AL
<b>Design</b>	Peter Nelson

## Series S

# AL



<b>FS2</b>	<b>Twin floor light</b>
<b>Guarantee</b>	10 years warranted and insured by Lloyd's of London
<b>Energy label</b>	F
<b>Lumens</b>	1275
<b>Watts</b>	15
<b>Lumen/Watts</b>	85
<b>Dimensions</b>	1390mm height
<b>Weight</b>	3950 grams
<b>Lamp</b>	R95 LED
<b>CCT</b>	3000K
<b>CRI</b>	80
<b>Beam angle</b>	120 degrees
<b>Certificate</b>	UKCA, CE, RoHS, Recolight
<b>Trade mark</b>	AL
<b>Design</b>	Peter Nelson



<b>A</b>	<b>Ceiling light</b>
<b>Guarantee</b>	10 years warranted and insured by Lloyd's of London
<b>Energy label</b>	F
<b>Lumens</b>	1275
<b>Watts</b>	15
<b>Lumen/Watts</b>	85
<b>Dimensions</b>	150mm projection
<b>Weight</b>	360 grams
<b>Lamp</b>	R95, LED, E27
<b>Beam angle</b>	35 degrees
<b>Certificate</b>	UKCA, CE, RoHS, Recolight
<b>Trade mark</b>	AL
<b>Design</b>	Peter Nelson



<b>A/SW</b>	<b>Wall light</b>
<b>Guarantee</b>	10 years warranted and insured by Lloyd's of London
<b>Energy label</b>	F
<b>Lumens</b>	1275
<b>Watts</b>	15
<b>Lumen/Watts</b>	85
<b>Dimensions</b>	150mm projection
<b>Weight</b>	360 grams
<b>Lamp</b>	R95, LED, E27
<b>Beam angle</b>	35 degrees
<b>Certificate</b>	UKCA, CE, RoHS, Recolight
<b>Trade mark</b>	AL
<b>Design</b>	Peter Nelson

## Series A

# AL



<b>TA</b>	<b>Table lamp</b>
<b>Guarantee</b>	10 years warranted and insured by Lloyd's of London
<b>Energy label</b>	F
<b>Lumens</b>	1275
<b>Watts</b>	15
<b>Lumen/Watts</b>	85
<b>Dimensions</b>	550mm height
<b>Weight</b>	1850 grams
<b>Lamp</b>	R95, LED, E27
<b>Beam angle</b>	120 degrees
<b>Certificate</b>	UKCA, CE, RoHS, Recolight
<b>Trade mark</b>	AL
<b>Design</b>	Peter Nelson

## Series A

# AL



<b>FA</b>	<b>Single floor light</b>
<b>Guarantee</b>	10 years warranted and insured by Lloyd's of London
<b>Energy label</b>	F
<b>Lumens</b>	1275
<b>Watts</b>	15
<b>Lumen/Watts</b>	85
<b>Dimensions</b>	1390mm height
<b>Weight</b>	3850 grams
<b>Lamp</b>	R95, LED, E27
<b>Beam angle</b>	120 degrees
<b>Certificate</b>	UKCA, CE, RoHS, Recolight
<b>Trade mark</b>	AL
<b>Design</b>	Peter Nelson

## Series A

# AL



<b>FA2</b>	<b>Twin floor light</b>
<b>Guarantee</b>	10 years warranted and insured by Lloyd's of London
<b>Energy label</b>	F
<b>Lumens</b>	1275
<b>Watts</b>	15
<b>Lumen/Watts</b>	85
<b>Dimensions</b>	1390mm height
<b>Weight</b>	4250 grams
<b>Lamp</b>	R95, LED x 2, E27
<b>Beam angle</b>	120 degrees
<b>Certificate</b>	UKCA, CE, RoHS, Recolight
<b>Trade mark</b>	AL
<b>Design</b>	Peter Nelson



<b>21</b>	<b>Ceiling or wall light made from aircraft grade hand polished anodised aluminium</b>
<b>Guarantee</b>	10 years warranted and insured by Lloyd's of London
<b>Energy label</b>	G
<b>Lumens</b>	690
<b>Watts</b>	9
<b>Lumen/Watts</b>	77
<b>Dimensions</b>	140mm projection
<b>Weight</b>	210 grams
<b>Lamp</b>	GU5.3 MR16 LED 12V
<b>CCT</b>	3000K
<b>CRI</b>	90
<b>Beam angle</b>	36 degrees
<b>Certificate</b>	UKCA, CE, RoHS, Recolight
<b>Trade mark</b>	AL
<b>Design</b>	Peter Nelson



**21T**                    **Ceiling or wall light made from aircraft grade hand polished anodised aluminium**

<b>Guarantee</b>	10 years warranted and insured by Lloyd's of London
<b>Energy label</b>	G
<b>Lumens</b>	690
<b>Watts</b>	9
<b>Lumen/Watts</b>	77
<b>Dimensions</b>	140mm projection
<b>Weight</b>	355 grams
<b>Lamp</b>	GU5.3 MR16 LED 12V
<b>CCT</b>	3000K
<b>CRI</b>	90
<b>Beam angle</b>	36 degrees
<b>Certificate</b>	UKCA, CE, RoHS, Recolight
<b>Trade mark</b>	AL
<b>Design</b>	Peter Nelson



**21/50**      **Ceiling or wall light made from aircraft grade hand polished anodised aluminium**

**Guarantee**      10 years warranted and insured by Lloyd's of London

**Energy label**      G

**Lumens**      690

**Watts**      9

**Lumen/Watts**      77

**Dimensions**      180mm projection

**Weight**      900 grams

**Lamp**      GU5.3 MR16 LED 12V

**CCT**      3000K

**CRI**      90

**Beam angle**      36 degrees

**Certificate**      UKCA, CE, RoHS, Recolight

**Trade mark**      AL

**Design**      Peter Nelson



<b>21 2x 50</b>	<b>Ceiling or wall light made from aircraft grade hand polished anodised aluminium</b>
<b>Guarantee</b>	10 years warranted and insured by Lloyd's of London
<b>Energy label</b>	G
<b>Lumens</b>	690
<b>Watts</b>	9
<b>Lumen/Watts</b>	77
<b>Dimensions</b>	220mm projection
<b>Weight</b>	1613 grams
<b>Lamp</b>	GU5.3 MR16 LED 12V
<b>CCT</b>	3000K
<b>CRI</b>	90
<b>Beam angle</b>	36 degrees
<b>Certificate</b>	UKCA, CE, RoHS, Recolight
<b>Trade mark</b>	AL
<b>Design</b>	Peter Nelson



<b>23/50</b>	<b>Single footlight</b>
<b>Guarantee</b>	10 years warranted and insured by Lloyd's of London
<b>Energy label</b>	G
<b>Lumens</b>	690
<b>Watts</b>	9
<b>Lumen/Watts</b>	77
<b>Dimensions</b>	180mm height
<b>Weight</b>	1226 grams
<b>Lamp</b>	GU 5.3
<b>CCT</b>	3000k
<b>CRI</b>	90
<b>Beam angle</b>	36 degrees
<b>Certificate</b>	UKCA, CE, RoHS, Recolight
<b>Trade mark</b>	AL
<b>Design</b>	Peter Nelson

## Series 20

# AL



<b>23/2x50</b>	<b>Double footlight</b>
<b>Guarantee</b>	10 years warranted and insured by Lloyd's of London
<b>Energy label</b>	G
<b>Lumens</b>	690
<b>Watts</b>	9
<b>Lumen/Watts</b>	77
<b>Dimensions</b>	220mm height
<b>Weight</b>	1900 grams
<b>Lamp</b>	GU5.3 MR16 LED 12V
<b>CCT</b>	3000k
<b>CRI</b>	90
<b>Beam angle</b>	36 degrees
<b>Certificate</b>	UKCA, CE, RoHS, Recolight
<b>Trade mark</b>	AL
<b>Design</b>	Peter Nelson

## Series 20

# AL

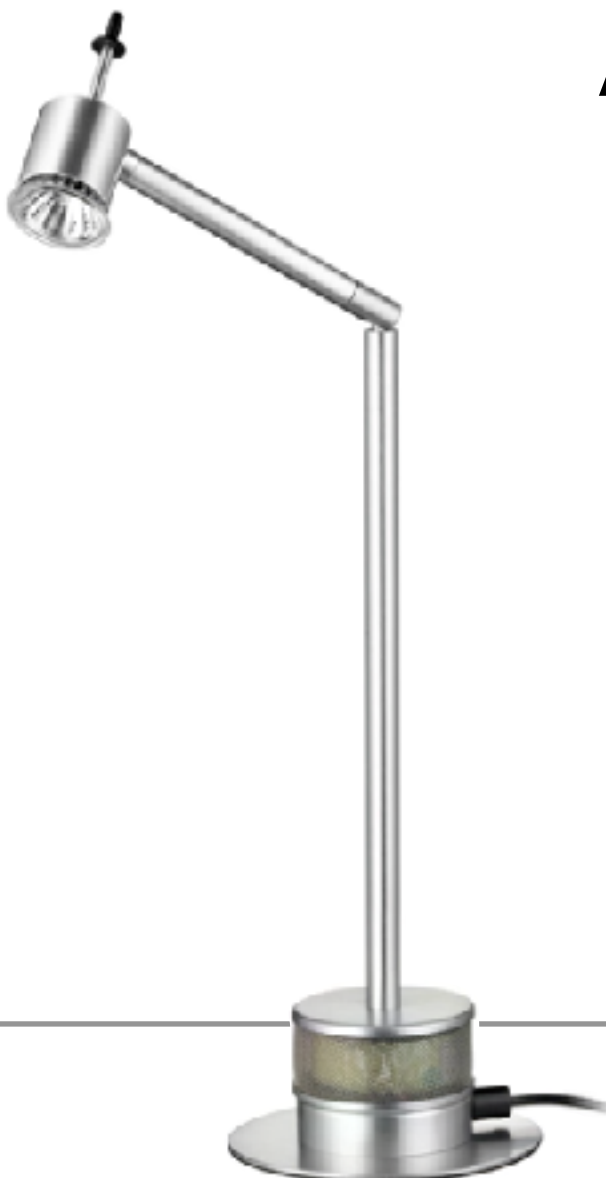

**25/50**

**Table light**

<b>Guarantee</b>	10 years warranted and insured by Lloyd's of London
<b>Energy label</b>	G
<b>Lumens</b>	690
<b>Watts</b>	9
<b>Lumen/Watts</b>	77
<b>Dimensions</b>	575mm height
<b>Weight</b>	1400 grams
<b>Lamp</b>	GU 5.3MR16 LED 12V
<b>CCT</b>	3000k
<b>CRI</b>	90
<b>Beam angle</b>	36 degrees
<b>Certificate</b>	UKCA, CE, RoHS, Recolight
<b>Trade mark</b>	AL
<b>Design</b>	Peter Nelson

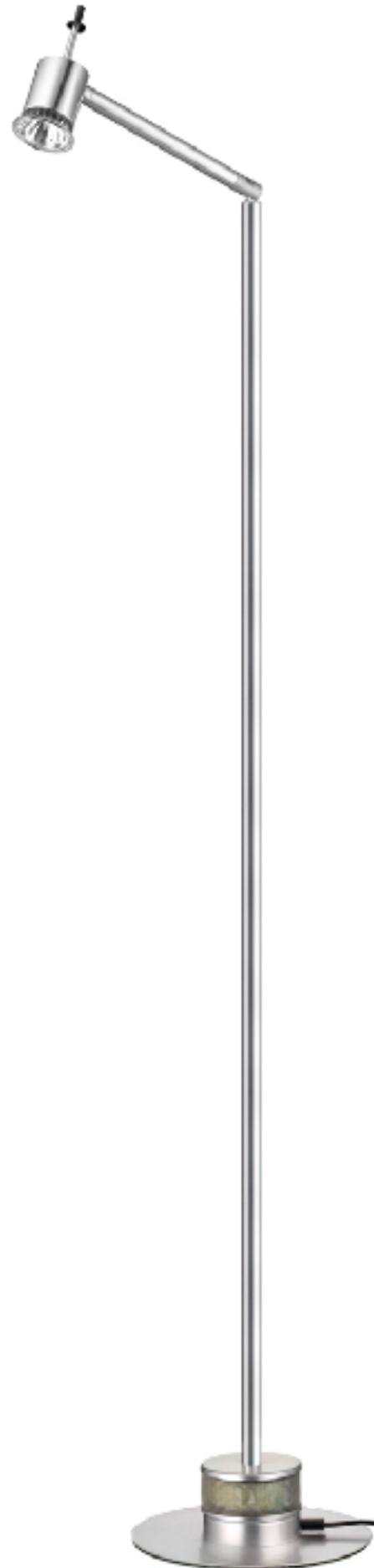

<b>26/50</b>	<b>Floor light</b>
<b>Guarantee</b>	10 years warranted and insured by Lloyd's of London
<b>Energy label</b>	G
<b>Lumens</b>	690
<b>Watts</b>	9
<b>Lumen/Watts</b>	77
<b>Dimensions</b>	1275mm height
<b>Weight</b>	1650 grams
<b>Lamp</b>	GU 5.3 MR16 LED 12V
<b>CCT</b>	3000k
<b>CRI</b>	90
<b>Beam angle</b>	36 degrees
<b>Certificate</b>	UKCA, CE, RoHS, Recolight
<b>Trade mark</b>	AL
<b>Design</b>	Peter Nelson



**31 Ceiling or wall light made from aircraft grade hand polished anodised aluminium**

<b>Guarantee</b>	10 years warranted and insured by Lloyd's of London
<b>Energy label</b>	G
<b>Lumens</b>	540
<b>Watts</b>	8
<b>Lumen/Watts</b>	73
<b>Dimensions</b>	130mm projection
<b>Weight</b>	230 grams
<b>Lamp</b>	B15d AR70 LED 12V reflector
<b>CCT</b>	3000k
<b>CRI</b>	90
<b>Beam angle</b>	25 degrees
<b>Certificate</b>	UKCA, CE, RoHS, Recolight
<b>Trade mark</b>	AL
<b>Design</b>	Peter Nelson



**31T**                    **Ceiling or wall light made from aircraft grade hand polished anodised aluminium**

**Guarantee**            10 years warranted and insured by Lloyd's of London

**Energy label**        G

**Lumens**                540

**Watts**                  8

**Lumen/Watts**        68

**Dimensions**        130mm projection

**Weight**                410 grams

**Lamp**                  B15d AR70 LED 12V reflector

**CCT**                    3000k

**CRI**                    90

**Beam angle**        25 degrees

**Certificate**         UKCA, CE, RoHS, Recolight

**Trade mark**         AL

**Design**                Peter Nelson



**31/50**      **Ceiling or wall light made from aircraft grade hand polished anodised aluminium**

**Guarantee**      10 years warranted and insured by Lloyd's of London

**Energy label**      G

**Lumens**      540

**Watts**      8

**Lumen/Watts**      68

**Dimensions**      170mm projection

**Weight**      955 grams

**Lamp**      B15d AR70 LED 12V reflector

**CCT**      3000k

**CRI**      90

**Beam angle**      25 degrees

**Certificate**      UKCA, CE, RoHS, Recolight

**Trade mark**      AL

**Design**      Peter Nelson



**31/2 x 50**      **Ceiling or wall light made from aircraft grade hand polished anodised aluminium**

**Guarantee**      10 years warranted and insured by Lloyd's of London

**Energy label**      G

**Lumens**      540

**Watts**      8

**Lumen/Watts**      68

**Dimensions**      220mm projection

**Weight**      1615 grams

**Lamp**      B15d AR70 LED 12V reflector

**CCT**      3000k

**CRI**      90

**Beam angle**      24 degrees

**Certificate**      UKCA, CE, RoHS, Recolight

**Trade mark**      AL

**Design**      Peter Nelson



<b>41</b>	<b>Ceiling or wall light made from aircraft grade hand polished anodised aluminium</b>
<b>Guarantee</b>	10 years warranted and insured by Lloyd's of London
<b>Energy label</b>	G
<b>Lumens</b>	540
<b>Watts</b>	14-8
<b>Lumen/Watts</b>	60
<b>Dimensions</b>	100mm projection
<b>Weight</b>	220 grams
<b>Lamp</b>	AR111 AR70 LED 12V reflector
<b>CCT</b>	3000k
<b>CRI</b>	90
<b>Beam angle</b>	24 degrees
<b>Certificate</b>	UKCA, CE, RoHS, Recolight
<b>Trade mark</b>	AL
<b>Design</b>	Peter Nelson



**41/2**      **Ceiling or wall light made from aircraft grade hand polished anodised aluminium**

**Guarantee**      10 years warranted and insured by Lloyd's of London

**Energy label**      G

**Lumens**      888

**Watts**      14-8

**Lumen/Watts**      60

**Dimensions**      170mm width

**Weight**      445 grams

**Lamp**      AR111 AR70 LED 12V reflector

**CCT**      3000k

**CRI**      90

**Beam angle**      24 degrees

**Certificate**      UKCA, CE, RoHS, Recolight

**Trade mark**      AL

**Design**      Peter Nelson



**41/4**      **Ceiling or wall light made from aircraft grade hand polished anodised aluminium**

**Guarantee**      10 years warranted and insured by Lloyd's of London

**Energy label**      G

**Lumens**      888

**Watts**      14-8

**Lumen/Watts**      60

**Dimensions**      1000mm width

**Weight**      1370 grams

**Lamp**      B15d AR70 LED 12V reflector

**CCT**      3000k

**CRI**      90

**Beam angle**      24 degrees

**Certificate**      UKCA, CE, RoHS, Recolight

**Trade mark**      AL

**Design**      Peter Nelson



**41/6**      **Ceiling or wall light made from aircraft grade hand polished anodised aluminium**

**Guarantee**      10 years warranted and insured  
by Lloyd's of London

**Energy label**      G

**Lumens**      888

**Watts**      14-8

**Lumen/Watts**      60

**Dimensions**      1500mm width

**Weight**      2000 grams

**Lamp**      B15d AR70 LED 12V reflector

**CCT**      3000k

**CRI**      90

**Beam angle**      24 degrees

**Certificate**      UKCA, CE, RoHS, Recolight

**Trade mark**      AL

**Design**      Peter Nelson

## Series 200

# AL



**201**      **Wall and ceiling light made from aircraft grade hand polished anodised aluminium**

**Guarantee**      10 years warranted and insured by Lloyd's of London

**Energy label**      G

**Lumens**      1110

**Watts**      8.5

**Lumen/Watts**      130

**Dimensions**      150mm projection

**Weight**      215 grams

**Lamp**      GU10 63mm dia LED

**CCT**      3000k

**CRI**      90

**Beam angle**      38 degrees

**Certificate**      UKCA, CE, RoHS, Recolight

**Trade mark**      AL

**Design**      Peter Nelson

## Series 200

# AL

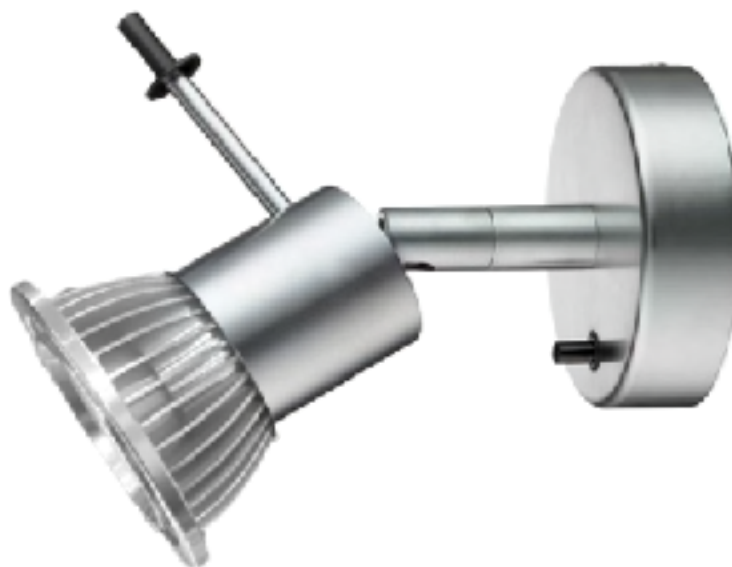

**201/SW**      **Switched wall light made from aircraft grade hand polished anodised aluminium**

**Guarantee**      10 years warranted and insured by Lloyd's of London

**Energy label**      G

**Lumens**      1110

**Watts**      8.5

**Lumen/Watts**      130

**Dimensions**      150mm projection

**Weight**      220 grams

**Lamp**      GU10 63mm dia LED

**CCT**      3000k

**CRI**      90

**Beam angle**      38 degrees

**Certificate**      UKCA, CE, RoHS, Recolight

**Trade mark**      AL

**Design**      Peter Nelson

## Series 200

# AL



**201/2**      **Twin ceiling light made from aircraft grade hand polished anodised aluminium**

**Guarantee**      10 years warranted and insured by Lloyd's of London

**Energy label**      G

**Lumens**      1110

**Watts**      8.5

**Lumen/Watts**      130

**Dimensions**      170mm projection

**Weight**      435 grams

**Lamp**      GU10 63mm dia LED

**CCT**      3000k

**CRI**      90

**Beam angle**      38 degrees

**Certificate**      UKCA, CE, RoHS, Recolight

**Trade mark**      AL

**Design**      Peter Nelson



**201/3 Triple ceiling light made from aircraft grade hand polished anodised aluminium**

**Guarantee** 10 years warranted and insured by Lloyd's of London

**Energy label** G

**Lumens** 1110

**Watts** 8.5

**Lumen/Watts** 130

**Dimensions** 280mm width

**Weight** 620 grams

**Lamp** GU10 63mm dia LED

**CCT** 3000k

**CRI** 90

**Beam angle** 38 degrees

**Certificate** UKCA, CE, RoHS, Recolight

**Trade mark** AL

**Design** Peter Nelson



**201/4**      **Four spot ceiling light made from aircraft grade hand polished anodised aluminium**

**Guarantee**      10 years warranted and insured by Lloyd's of London

**Energy label**      G

**Lumens**      1110

**Watts**      8.5

**Lumen/Watts**      130

**Dimensions**      1000mm width

**Weight**      1350 grams

**Lamp**      GU10 63mm dia LED

**CCT**      3000k

**CRI**      90

**Beam angle**      38 degrees

**Certificate**      UKCA, CE, RoHS, Recolight

**Trade mark**      AL

**Design**      Peter Nelson



**201/6**      **Six spot ceiling light made from aircraft grade hand polished anodised aluminium**

**Guarantee**      10 years warranted and insured by Lloyd's of London

**Energy label**      G

**Lumens**      1110

**Watts**      8.5

**Lumen/Watts**      130

**Dimensions**      1500mm width

**Weight**      1970 grams

**Lamp**      GU10 63mm dia LED

**CCT**      3000k

**CRI**      90

**Beam angle**      38 degrees

**Certificate**      UKCA, CE, RoHS, Recolight

**Trade mark**      AL

**Design**      Peter Nelson

## Series 200

# AL



---

**205**                      **Table light made from aircraft grade hand polished anodised aluminium**

**Guarantee**            10 years warranted and insured by Lloyd's of London

**Energy label**        E

**Lumens**                1110

**Watts**                 8.5

**Lumen/Watts**        130

**Dimensions**         690mm height

**Weight**                2180 grams

**Lamp**                 GU10 63mm dia LED

**CCT**                  3000k

**CRI**                    90

**Beam angle**         38 degrees

**Certificate**         UKCA, CE, RoHS, Recolight

**Trade mark**        AL

**Design**              Peter Nelson

## Series 200

# AL

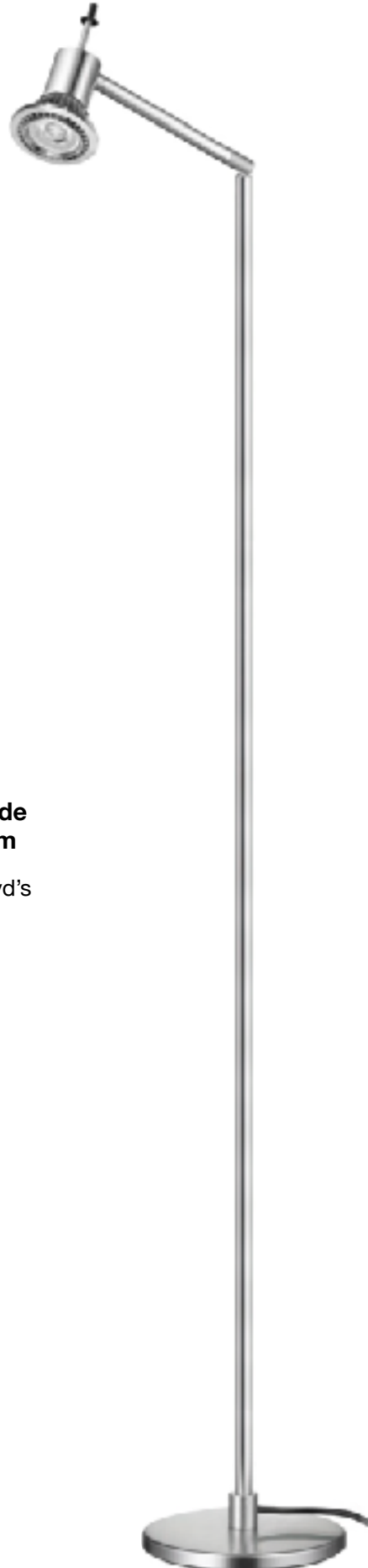

<b>206</b>	<b>Floor light made from aircraft grade hand polished anodised aluminium</b>
<b>Guarantee</b>	10 years warranted and insured by Lloyd's of London
<b>Energy label</b>	G
<b>Lumens</b>	1110
<b>Watts</b>	8.5
<b>Lumen/Watts</b>	130
<b>Dimensions</b>	1450mm height
<b>Weight</b>	3605 grams
<b>Lamp</b>	GU10 63mm dia LED
<b>CCT</b>	3000k
<b>CRI</b>	90
<b>Beam angle</b>	38 degrees
<b>Certificate</b>	UKCA, CE, RoHS, Recolight
<b>Trade mark</b>	AL
<b>Design</b>	Peter Nelson

## Downlight



<b>Downlight</b>	<b>Round white bathroom downlight</b>
<b>Guarantee</b>	10 years warranted and insured by Lloyd's of London
<b>Lumens</b>	450 or 630
<b>Watts</b>	5 or 7 GU10 dim or non-dim
<b>Dimensions</b>	Dia. 85mm, Height 73mm
<b>Cut out</b>	75mm
<b>Certificate</b>	UKCA, CE, RoHS, Recolight
<b>Trade mark</b>	AL
<b>Glass</b>	Clear or Opal
<b>IP</b>	65, Bathroom

# Downlight

# AL

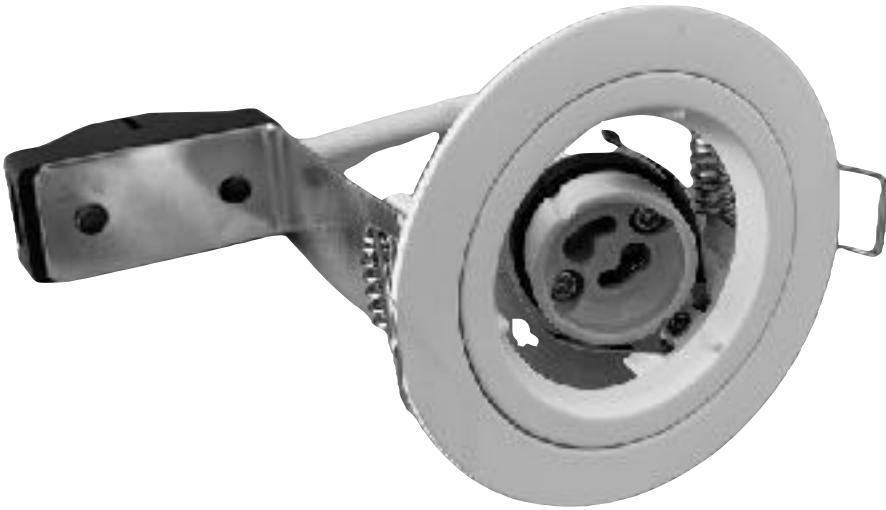

<b>Downlight</b>	<b>Fixed downlight - white</b>
<b>Guarantee</b>	10 years warranted and insured by Lloyd's of London
<b>Dimensions</b>	Dia. 80mm, Silicon 15cm cable, metal strip: Terminal block and GU10 holder
<b>Cut out</b>	70mm
<b>Certificate</b>	UKCA, CE, RoHS, Recolight
<b>Trade mark</b>	AL
<b>IP</b>	20, general use

## GU10

# AL



<b>GU10</b>	<b>Dim or non-dim</b>
<b>Guarantee</b>	10 years warranted and insured by Lloyd's of London
<b>Lumens</b>	450 or 630
<b>Energy label</b>	F
<b>Watts</b>	5 or 7
<b>CCT</b>	3000K
<b>CRI</b>	80
<b>Dimensions</b>	Dia. 50mm, Height 55.5mm
<b>Service Life</b>	50,000 hours
<b>Beam angle</b>	38 degrees
<b>Dimmable</b>	Non dim or dimmable use Varilight V-Pro 300watt
<b>Certificate</b>	UKCA, CE, RoHS, Recolight
<b>Trade mark</b>	AL

"that which is not worth doing,  
is not worth doing well"

Warren Buffett

# **Allom**

# **Architectural Lighting**