

Allom

Architectural Lighting

The object is the object - Studio FPM 1973



God is in the Details - Mies Van de Rohe 1929

Awards

Design awards, Italy, Germany, USA and UK

Product in Museum of Modern Art, New York, MOMA, since 1973



MOMA

Logistics

Allom Architectural Lighting delivers all over Europe via London, Antwerp, Berlin, Milan, Paris, Warsaw, Zurich.

Gulf and Asia Pacific - Dubai, Doha, Mumbai, Seoul, Singapore, Sydney, and Tokyo.

USA - Baltimore, Cleveland, Houston, Long Beach.

Digital Infrastructure

Revit, Cobuilder, Solidworks, Adobe Creative Suite, Sage 50, Office 365.

Product Compliance

Guarantee - 10 years warranted and insured by Lloyd's of London

Heat transfer thermal dynamics convection cooling laminar flow

Allom Cool Head Technology™

OPTIM•AL™

385+ luminaires;

£5m product liability insurance for each major market;

a solid state company for electronics research and development.

Long product life, recyclable, biodegradable packaging Industrial, Retail, Residential.

TUV / CE/ Rohs / Recolight / UKCA ISO 9001 ISO 14001

Timing is everything

- 1961** Peter Nelson, Britains foremost aircraft modeller, starts AL, designs and makes Series S.
Prior to this he modelled 12 versions of the Constellation aeroplane working with Howard Hughes.
- 1967** Series A designed and made. 'More with less'.
750watt Light Box for retail, and gallery lighting.
- 1972** AL is the first lighting business in Europe to give a 5 year guarantee.
- 1974** Manufacture in Japan, USA and Italy.
'The Object is the object', the purpose of our work is to make better products
and a better world.
- 1975** Cylinder Series UK and USA, 'The best for the most with the least'
- 1982** Series 20, mr16
- 1987** Series 30, B15d
- 1990** Series 900
- 1992** Allom picture lights
- 1995** Series 200, GU10
- 2004** Series 40, AR111, Allom Cool Head Technology™
- 2008** LED modules, Newton Series, patented UK, EU, USA, Brunel, Red Dot.
- 2017** Greenlight for vertical farming
- 2021** Medic-AL, Dept. for Health, Covid solution.
- 2022** Electric Vehicle charging point for kerbside,
Skyraft patented UK, EU, USA & Skydisk.
- 2023** Energy saving patented projectors for track and ceiling plate.
- 2024** OPTIM-AL 10 years warranted and insured

Philosophy

We work continuously for a better world with longer product life, 98% recycling and always following the maxim of R. Buckminster Fuller: more with less.

Wir arbeiten permanent an der verbesserung unserer produkte, um deren lebensdauer und 98% recyclebarkeit zu gewährleisten. Unser motto ist die maxime von R. Buckminster Fuller: more with less.

Nous travaillons continuellement pour un monde meilleur avec une duree de vie de produit plus longue, 98% recyclable et en suivant toujours la maxime de R. Buckminster Fuller: more with less.

Lavoriamo in continuazione per creare un mondo, con prodotti di lunga durata e riciclabili al 98%. Tuttocio sempre seguendo il motto di R. Buckminster Fuller: more with less.

Nosotros trabajamos continuamente para crear un mundo mejor, con productos más duraderos, reciclables en un 98% y siempre siguiendo el lema de R.Buckminster Fuller: more with less.

Nós trabalhamos continuamente para criar um mundo melhor, com produtos de longa duração, 98% reciclando e sempre seguindo o lema de R. Buckminster Fuller: more with less.

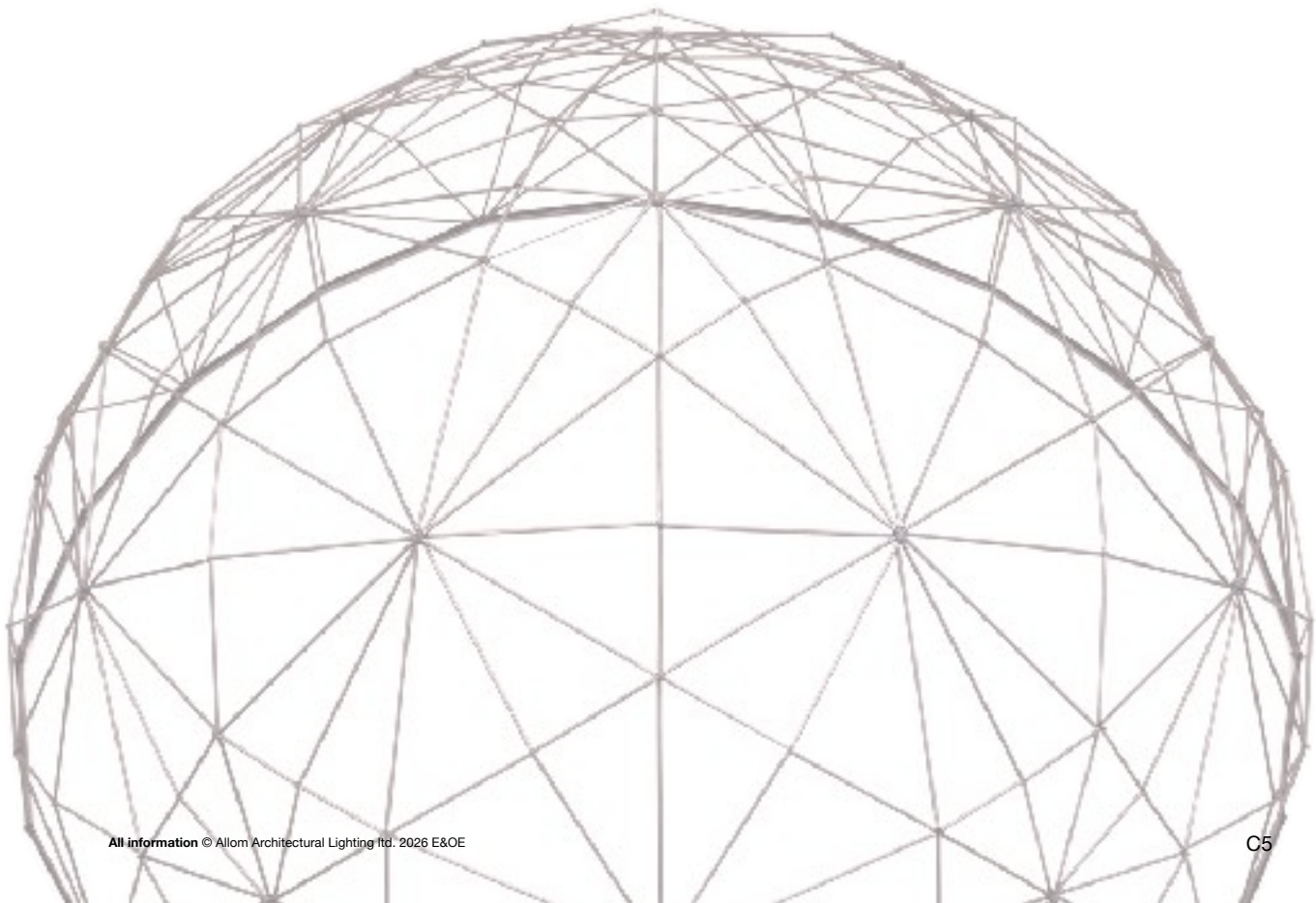

Influences

"We do these things not because they are easy but because they are hard" -

President John F Kennedy

"God is in the details" - Mies van der Rohe

"One thing will be decisive the way we assert ourselves in the face
of circumstance" - Mies van der Rohe

"We cross the river by feeling the stones" - Deng Xiaoping

"An engineer can be an artist, but an artist cannot be an engineer" -

Frank Malina, Paris 1966

"The object is the object. The purpose of our work is to make better products
and a better world" - Studio FPM, Milan 1972

"More with less" - R. Buckminster Fuller

"The best for the most with the least" - Ray Eames

"Design is not about decoration; it is about creating a space that enhances life" –

Charlotte Perriand

Pythagoras, Fibonacci, Galileo, Newton, Faraday, Swan, Tatlin, Malevitch,
Rodchenko, Lissitsky, Aalto, van der Rohe, Takis, Malina, Gabo, Spencer, Castelli,
Magistretti, Castiglione, Straub, Boothby, Kape, Mari.



Products - All with 10 year guarantee

OPTIM●AL

GU10	1.9 watt 398 lumen non dim 36 degree 50,000 hours Energy label A
INTEGRATED	5 watt 600 lumens dim 3/4/6K switchable, CRI90, IP65 fire rated 90mins 38 degree Energy label E
CIRCULAR	Bulkhead with only 68mm projection 12 watts, 1440 lumens, 3/4/6.5K switchable, IP65 on-off, micro-sensor, EM, 3 year 2x batteries, 3 hours Li-ion. Energy Label E Bulkhead with 78mm projection to take a 20mm conduit tube 12 watts, 1440 lumens, 3/4/6.5K switchable, IP65 on-off, micro-sensor, EM, 3 year 2x batteries, 3 hours Li-ion for 20% output. Energy Label E
SKYDISK	Circular Highbay, 298mm dia 145 watt 29725 lumen IP65, 60,000 hours service life, 3 metre chainset and 3 metre power cable 4/5/6.6K switchable, Beam 55 or 85 degrees EM version as above but with 3 year, 3 hour Li-Ion battery for 10%. Energy label B
SKYRAFT	Linear Highbay, Made in Aluminium. Energy saving, COOL BRIDGE, IP65. Optional EM version at 20% performance for 3 hours with 3 Li-ION batteries with 3 year battery life. 3.5 metre chains and 3.5 metre power feeds as required 10 year guarantee, 80,000 Service life 3/4/5/6K switchable Energy label D
DREADNOUGHT	Bulkhead Series, Diecast Stainless steel body, 20/30/50 watts, 3000, 5000, 8000 lumen 3/4/5/6K switchable, M/S, Fire rated 90 minutes EM version available 20% for 3 hours and 3 year life Energy label C and E
PROJECTOR	Fixed Beam Track and ceiling plate. The overall wattage for major retail stores is 15watts. 2400lm, 160lm/watt Energy label C
NEWTON	A series of 17 task lights at 8 watts and 1280 lumens, the best in class, with a universal dimmable driver at 97v-277v Energy label C
EVCP	Rapid Electrical Vehicle Charging Point



OPTIM•AL



Guarantee

Energy

Product Code

OPGU10A3983N36UKEU

OPTIM•AL GU10 Longlife/Glass

Guarantee	10 years warranted and insured by Lloyd's of London
Energy Label	A
Watts	1.9 Watts
Lumens	398 Lumens
CCT	3000k, lumens/watt 210
CRI	80
Dimensions	Dia. 50mm, Height 55.5mm
Service Life	50,000 Hours
Beam Angle	36 Degrees
Dimmable	Non Dim
Certifications	UKCA CE RoHS SELV Recolight, ISO 9001 ISO 14001
Driver	Constant Current
Trade Mark	OPTIM•AL



OPTIM•AL



Guarantee

Energy

Product Code

OPINTE600346D900365FR90UKEU

INTEGRATED FIREPROOF

Integrated downlight fire rated

Fire Rated	90 minutes
Guarantee	10 years warranted and insured by Lloyd's of London
Energy Label	E
Watts	5
Lumens	600
Lumens per Watt	120
CCT	3/4/6k switchable
CRI	80
Dimensions	Dia. 84mm, cut out 68mm dia
Service Life	60,000 Hours rating
Beam Angle	38 Degrees
Bezel	RAL 9003 White
Dimmable	Dimmable recommended with Varilight Pro
IP	IP65
Certifications	CE RoHS SELV, UKCA, Recolight, VDE, TUV ISO 9001, ISO 14001, SEDEX & SMETA
Trade mark	OPTIM•AL



OPTIM•AL



Guarantee

Energy

Product Code

OPCIRCE14403465N900354UKEU
OPCIRCE14403465N901054UKEU
OPCIRCE14403465N900354MSUKEU
OPCIRCE14403465N901054MSUKEU
OPCIRCE14403465N90039054EMUKEU
OPCIRCE14403465N90109054EMUKEU
OPCIRCE14403465N90039054EMMSUKEU
OPCIRCE14403465N90109054EMMSUKEU

CIRCULAR BULKHEAD

Fire Retardant Polycarbonate

Guarantee	10 years warranted and insured by Lloyd's of London
Energy label	E
Lumens	1440
Lumens/Watt	120 lumens at 12 watts
Watts	12 Watts, Non DIM
CCT	3000K/4000K/6500K switchable
CRI	80
Colour	RAL 9003 White or RAL 9010 Warm White
Driver	PF95
Certificate	TUV CE Rohs Recolight
Dimensions	315mm dia, 68mm projection
Service Life	50000 hours /10 years, 2x Li-Ion batteries at 3.2V and 150mAh, total 6.4V and 300mAh, 3 years and 3 hours
Uses	General lighting, ceiling or wall, stairs and communal areas
IP	IP65
Design & Copyright	Studio FPM
Trade Mark	OPTIM•AL



OPTIM•AL



Guarantee



Energy

Product Code

OPCIRCCONE14403465N900365UKEU
OPCIRCCONE14403465N900365MSUKEU
OPCIRCCONE14403465N900365EMUKEU
OPCIRCCONE14403465N900365EMMSUKEU

CIRCULAR BULKHEAD

Fire Retardant Polycarbonate

Guarantee	10 years warranted and insured by Lloyd's of London
Energy label	E
Lumens	1440
Lumens/Watt	120 lumens at 12 watts
Watts	12 Watts, Non DIM
CCT	3000K/4000K/6500K switchable
CRI	80
Colour	RAL 9003 White or RAL 9010 Warm White
Driver	PF95
Certificate	TUV CE Rohs Recolight
Dimensions	315mm dia, 78mm projection to take a 20mm conduit tube
Service Life	50000 hours /10 years, 2x Li-Ion batteries at 3.2V and 150mAh, total 6.4V and 300mAh, 3 years and 3 hours
Uses	General lighting, ceiling or wall, stairs and communal areas
IP	IP65
Design & Copyright	Studio FPM
Trade Mark	OPTIM•AL



OPTIM•AL



Guarantee.

Energy

Product Code

- OPDISKB29725456.565UKEU
- OPDISKB29725456.565EMUKEU
- OPDISKB20500456.565UKEU
- OPDISKB20500456.565EMUKEU
- OPDISKB15375456.565UKEU
- OPDISKB15375456.565EMUKEU

SKY DISK

Top Spec Circular Highbay Series with 3 lumen outputs

Guarantee	Flicker Free – 10 years warranted and insured Lloyd’s of London
Material	High pressure die cast aluminum body, RAL 9004
Lumens	29725, 20500, 15375, Lumileds 2835
Watts	145, 100, 75
CCT	4/5/6.5k Switchable, beam 55 or 85 degrees
CRI	80
Types	On-off, MS, 3 metre power feeds and 3 metre chainsets EM version with 10% output on 3 or 2 Li-Ion batteries, 3 hours and 3 years life, smart controls on application, Bluetooth, Dali, ZigBee
Driver	1x Lifud, 200watt for 145, 100 or 75 watts
Certificate	TUV, CE, RoHS, SELV, Recolight, UKCA
Dimensions	298mm dia, weight 4 or 6 kg
Service Life	60,000 hours
Uses	Industrial, Warehouse, Rail
IP	IP65
Design	Studio FPM
Trade mark	OPTIM•AL™ Allom Cool Head Technology™

Energy Saving
Skyraft



OPTIM•AL



Guarantee

Energy

Product Code

OPRAFTC27700456DMSUKEU
OPRAFTC27700456DMSEMUKEU
OPRAFTC20775456DMSUKEU
OPRAFTC20775456DMSEMUKEU
OPRAFTC13850456DMSUKEU
OPRAFTC13850456DMSEMUKEU

SkyRaft	Top specification Highbay with COOL BRIDGE
Guarantee	Flicker free; 10 years, warranted and insured Lloyd's of London
Energy Label	D
Material	Aluminium
Lumens	Lumens per watt 143, for 25000 total lumens
Watts/Voltage	175w, 97-277v
CCT	4/6K Switchable
CRI	80
Beam Angle	90 degrees
Types	On-off, MS, dim and/or EM Li-Ion 3 x 3 hour or 2 x 3 hour at 20%, 3 year life. Casambi on application STOOW power cable and chain standard 3.5m long or length to order, ATEX ZONE 2, fireproof dust cover
Drivers	1 x isolated Inventronic at 200w
Certificate	VDE, TUV, UKCA, CE, Rohs, SELV, Recolight, UL, CUL, ATEX Zone 2
Dimensions	900 x 453 x 52 mm Weight 6.3kg or EM 8.3kg
Service life	80000 hours L70
Uses	Data Centres, Battery factories, Distribution centres, Industrial Depots
IP	54, IK08
Design	Studio FPM
Trademark	OPTIM•AL : Patented UK, EU, USA. Allom Cool Head Technology™

Energy Saving
Skyraft

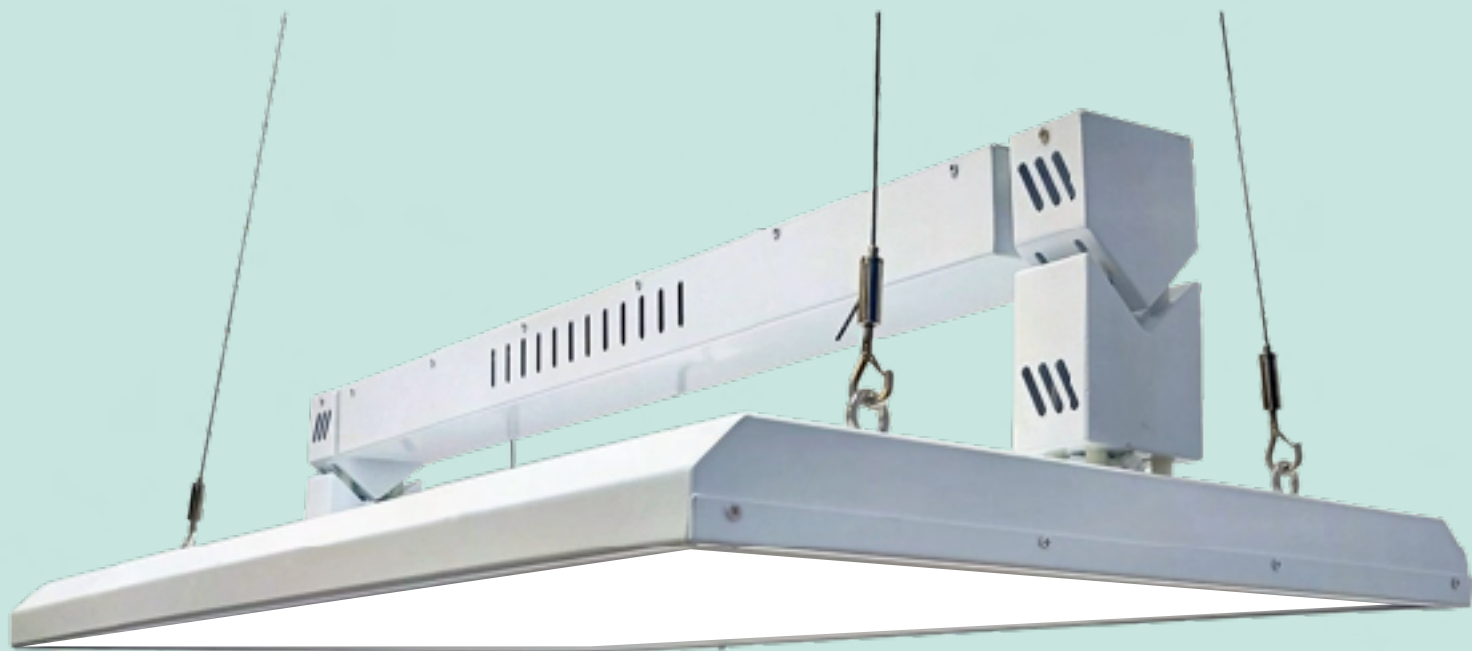

Data Centres

Battery Factories

Distribution Centres

Industrial Depots

Patented UK, EU, USA

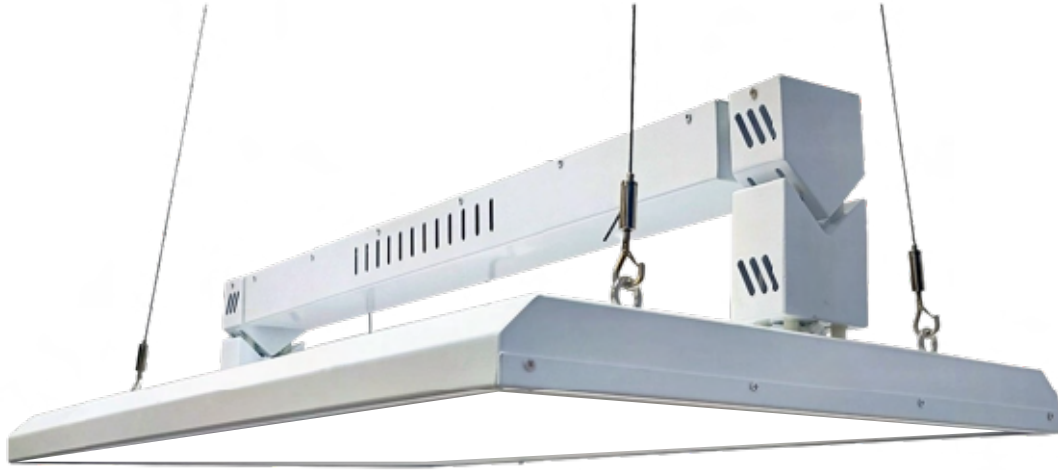

10 year guarantee

Certificated & insured by Lloyds of London

TUV, VDE, CE, Nemko, UKCA, UL, CUL

23625 Lumens

175 Watts

4000 or 6000K

90,000 hour rating

850 x 452 x 202 mm

34 x 18 x 8-75 inches

Standard version 6.30 kilos

Standard version 14 lbs

Emergency version 8.30 kilos

Emergency version 18.25 lbs

Energy Label D

Allom Cool Head
Technology™
patented in UK,
France, Germany
and USA.

Bridge temperature is
37-5C, allowing us to
guarantee and insure
the driver for ten years
and the Li-ion batteries
in the emergency
version for three years.



LUMINAIRE PHOTOMETRIC TEST REPORT

Test:U:219.36V I:0.7778A P:166.71W PF:0.9771 Freq:50.00Hz Lamp Flux:22214.1x1 lm		
NAME: LSLH-175W	TYPE:	WEIGHT:
SPEC.:	DIM.:	SERIAL No.:LSLH-170W
MFR.: LSLH	SUR.:	Shielding Angle:

DATA OF LAMP		PHOTOMETRIC DATA				Eff: 133.25 lm/W
MODEL	LSLH-175W	I _{max} (cd)	6699	S/MH (C0/180)		1.27
NOMINAL POWER (W)	175	LOR (%)	100.0	S/MH (C90/270)		1.30
RATED VOLTAGE (V)	220	TOTAL FLUX (lm)	22214	η UP, DN (C0-180)		0.7,47.6
NOMINAL FLUX (lm)	22214.1	CIE CLASS	DIRECT	η UP, DN (C180-360)		0.7,51.1
LAMPS INSIDE	1	η up (%)	1.4	CIBSE SHR NOM		1.25
TEST VOLTAGE (V)	220	η down (%)	98.6	CIBSE SHR MAX		1.35

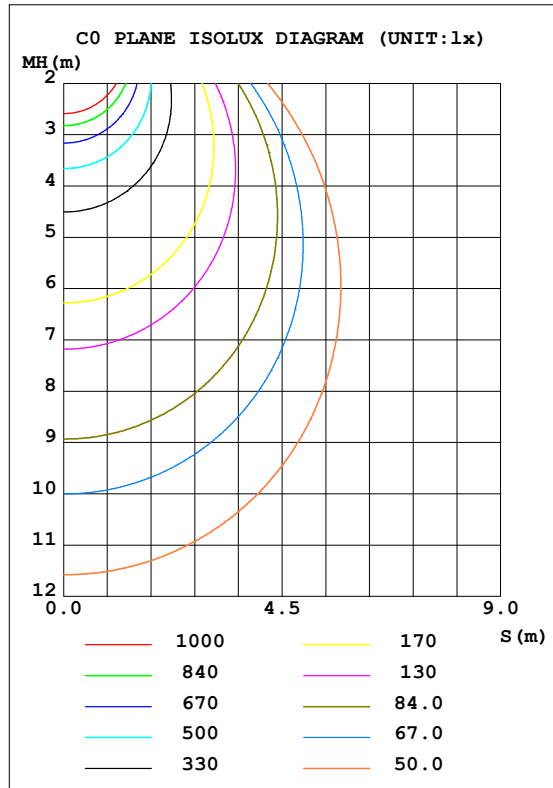
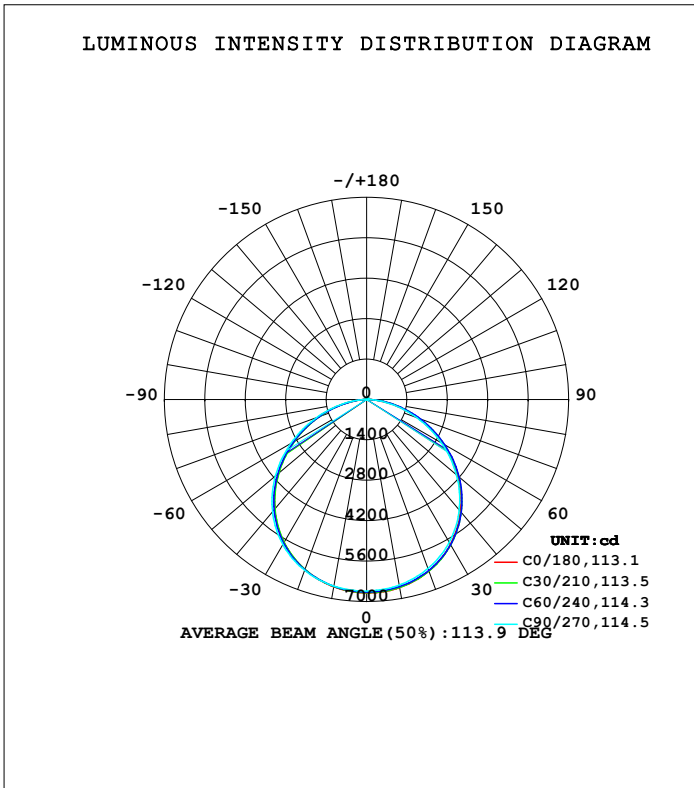

C Range: 0 - 360DEG
C Interval: 30.0DEG
Test Speed: HIGH
Temperature: 25.3DEG
Operators: H
Test Date: 2025-07-24

γ Range: 0 - 180DEG
γ Interval: 1.0DEG
Test System: EVERFINE GO-2000B_V1 SYSTEM V2.0.404.7
Humidity: 65.0%
Test Distance: 4.430m [K=1.0000]
Remarks:

ZONAL FLUX DIAGRAM

ZONAL FLUX DIAGRAM:

γ	C0	C45	C90	C135	C180	C225	C270	C315	γ	Φ zone	Φ total	%lum,lamp
10	6613	6592	6525	6393	6586	6573	6561	6622	0- 10	630.1	630.1	3.2,3.2
20	6321	6312	6228	5981	6265	6265	6294	6445	10- 20	1816	2447	12.4,12.4
30	5803	5818	5721	5352	5720	5731	5804	6052	20- 30	2780	5227	26.5,26.5
40	5054	5098	4992	4514	4950	4965	5073	5420	30- 40	3379	8605	43.7,43.7
50	4108	4175	4063	3515	3989	3995	4123	4559	40- 50	3513	12118	61.5,61.5
60	3027	3107	2990	2421	2906	2890	3020	3518	50- 60	3160	15278	77.5,77.5
70	1898	1977	1861	1328	1788	1746	1858	2378	60- 70	2394	17673	89.6,89.6
80	821.2	893.5	791.0	347.1	733.7	676.3	763.1	1248	70- 80	1382	19055	96.7,96.7
90	19.09	32.21	19.20	21.87	20.17	20.48	19.97	247.7	80- 90	389.2	19444	98.6,98.6
100	24.51	23.69	24.47	28.43	26.37	26.19	24.90	22.66	90-100	31.69	19476	98.8,98.8
110	33.12	31.66	32.44	36.75	34.92	34.15	32.47	30.10	100-110	30.52	19506	98.9,98.9
120	43.49	41.33	41.60	46.73	44.57	43.65	41.06	39.15	110-120	37.79	19544	99.1,99.1
130	51.11	48.47	47.88	53.81	51.19	49.63	46.23	45.12	120-130	41.34	19585	99.3,99.3
140	56.57	53.93	52.67	57.41	56.37	54.00	50.85	50.44	130-140	39.98	19625	99.6,99.6
150	61.16	59.60	57.63	60.07	61.05	56.90	55.79	56.02	140-150	35.22	19661	99.7,99.7
160	66.64	65.97	62.44	65.66	66.80	61.91	61.29	62.44	150-160	28.19	19689	99.9,99.9
170	71.43	69.42	65.20	68.72	73.80	67.81	65.23	67.64	160-170	18.83	19708	100,100
180	66.11	62.76	59.81	61.79	66.15	62.75	59.90	61.79	170-180	6.442	19714	100,100
DEG	LUMINOUS INTENSITY:cd									UNIT:lm		

C Range: 0 - 360DEG
 C Interval: 30.0DEG
 Test Speed: HIGH
 Temperature:25.3DEG
 Operators:H
 Test Date:2025-07-24

γ Range: 0 - 180DEG
 γ Interval: 1.0DEG
 Test System:EVERFINE GO-2000B_V1 SYSTEM V2.0.404.7
 Humidity:65.0%
 Test Distance:4.430m [K=1.0000]
 Remarks:

LUMINANCE LIMITATION CURVES

Test:U:219.36V I:0.7778A P:166.71W PF:0.9771 Freq:50.00Hz Lamp Flux:22214.1x1 lm		
NAME: LSLH-175W	TYPE:	WEIGHT:
SPEC.:	DIM.:	SERIAL No.:LSLH-170W
MFR.: LSLH	SUR.:	Shielding Angle:

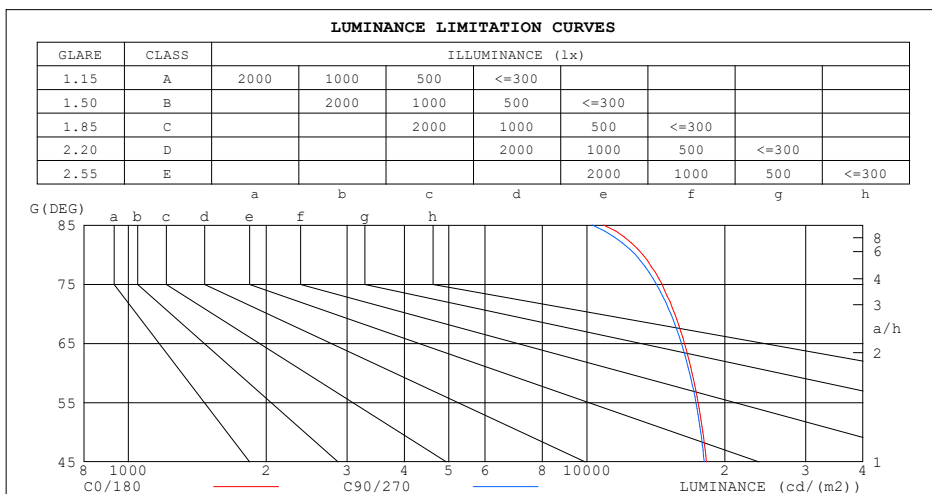

LUMINANCE cd/(m2)		
G (DEG)	C0/180	C90/270
85	10870	10279
80	13250	12763
75	14590	14186
70	15546	15246
65	16325	16082
60	16964	16754
55	17489	17292
50	17906	17710
45	18243	18031

C Range: 0 - 360DEG
C Interval: 30.0DEG
Test Speed: HIGH
Temperature:25.3DEG
Operators:H
Test Date:2025-07-24

γ Range: 0 - 180DEG
γ Interval: 1.0DEG
Test System:EVERFINE GO-2000B_V1 SYSTEM V2.0.404.7
Humidity:65.0%
Test Distance:4.430m [K=1.0000]
Remarks:

CU AND LUMINAIRE BUDGETARY ESTIMATE DIAGRAM

Test:U:219.36V I:0.7778A P:166.71W PF:0.9771 Freq:50.00Hz Lamp Flux:22214.1x1 lm		
NAME: LSLH-175W	TYPE:	WEIGHT:
SPEC.:	DIM.:	SERIAL No.:LSLH-170W
MFR.: LSLH	SUR.:	Shielding Angle:

ρ_{cc}	80%			70%			50%			30%			10%			0
ρ_w	50%	30%	10%	50%	30%	10%	50%	30%	10%	50%	30%	10%	50%	30%	10%	0
ρ_{fc}	20%			20%			20%			20%			20%			0
RCR	RCR:Room Cavity Ratio						Coefficients of Utilization (CU)									
0.0	1.19	1.19	1.19	1.16	1.16	1.16	1.10	1.10	1.10	1.05	1.05	1.05	1.01	1.01	1.01	.99
1.0	1.03	.99	.95	1.01	.97	.94	.97	.93	.90	.92	.90	.87	.89	.86	.85	.82
2.0	.90	.83	.77	.88	.82	.76	.84	.79	.74	.81	.76	.72	.78	.74	.71	.68
3.0	.79	.71	.64	.77	.70	.63	.74	.68	.62	.71	.66	.61	.68	.64	.60	.57
4.0	.70	.61	.54	.68	.60	.54	.66	.59	.53	.63	.57	.52	.61	.56	.51	.49
5.0	.62	.53	.47	.61	.53	.46	.59	.51	.46	.57	.50	.45	.55	.49	.44	.42
6.0	.56	.47	.41	.55	.47	.40	.53	.46	.40	.51	.45	.39	.50	.44	.39	.37
7.0	.51	.42	.36	.50	.42	.36	.48	.41	.35	.47	.40	.35	.45	.39	.35	.33
8.0	.46	.38	.32	.46	.37	.32	.44	.37	.31	.43	.36	.31	.41	.35	.31	.29
9.0	.42	.34	.29	.42	.34	.29	.41	.33	.28	.39	.33	.28	.38	.32	.28	.26
10.0	.39	.31	.26	.39	.31	.26	.38	.30	.26	.36	.30	.25	.35	.30	.25	.24

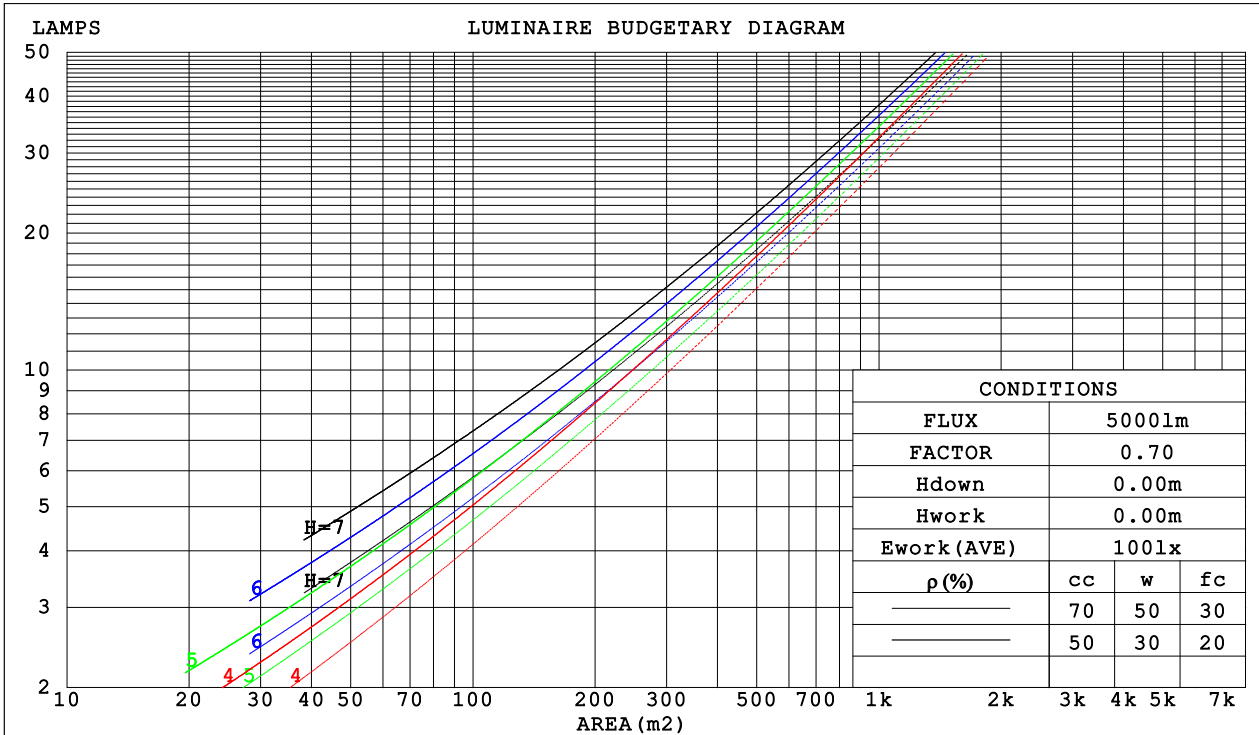

C Range: 0 - 360DEG
C Interval: 30.0DEG
Test Speed: HIGH
Temperature:25.3DEG
Operators:H
Test Date:2025-07-24

γ Range: 0 - 180DEG
 γ Interval: 1.0DEG
Test System:EVERFINE GO-2000B_V1 SYSTEM V2.0.404.7
Humidity:65.0%
Test Distance:4.430m [K=1.0000]
Remarks:

WEC AND CCEC

Test:U:219.36V I:0.7778A P:166.71W PF:0.9771 Freq:50.00Hz Lamp Flux:22214.1x1 lm		
NAME: LSLH-175W	TYPE:	WEIGHT:
SPEC.:	DIM.:	SERIAL No.:LSLH-170W
MFR.: LSLH	SUR.:	Shielding Angle:

ρcc	80%			70%			50%			30%			10%			0
ρw	50%	30%	10%	50%	30%	10%	50%	30%	10%	50%	30%	10%	50%	30%	10%	0
ρfc	20%			20%			20%			20%			20%			0
RCR	RCR:Room Cavity Ratio						Wall Exitance Coefficients (WEC)									
0.0																
1.0	.311	.177	.056	.304	.173	.055	.290	.166	.053	.277	.160	.051	.265	.153	.049	
2.0	.292	.160	.049	.286	.157	.048	.273	.152	.047	.262	.147	.046	.251	.142	.045	
3.0	.270	.144	.043	.265	.142	.043	.254	.137	.042	.243	.133	.041	.234	.129	.040	
4.0	.249	.130	.038	.244	.128	.038	.234	.124	.037	.225	.121	.037	.217	.118	.036	
5.0	.231	.117	.034	.226	.116	.034	.217	.113	.033	.209	.110	.033	.201	.108	.032	
6.0	.214	.107	.031	.210	.106	.030	.202	.103	.030	.195	.101	.030	.188	.099	.029	
7.0	.199	.098	.028	.195	.097	.028	.188	.095	.027	.182	.093	.027	.176	.091	.027	
8.0	.186	.091	.026	.182	.090	.025	.176	.088	.025	.170	.086	.025	.165	.085	.025	
9.0	.174	.084	.024	.171	.083	.023	.165	.082	.023	.160	.080	.023	.155	.079	.023	
10.0	.164	.078	.022	.161	.078	.022	.156	.076	.022	.151	.075	.021	.146	.074	.021	

ρcc	80%			70%			50%			30%			10%			0
ρw	50%	30%	10%	50%	30%	10%	50%	30%	10%	50%	30%	10%	50%	30%	10%	0
ρfc	20%			20%			20%			20%			20%			0
RCR	RCR:Room Cavity Ratio						Ceiling Cavity Exitance Coefficients (CCEC)									
0.0																
1.0	.201	.201	.201	.172	.172	.172	.117	.117	.117	.067	.067	.067	.022	.022	.022	
2.0	.183	.142	.109	.157	.123	.094	.107	.085	.065	.062	.049	.038	.020	.016	.012	
3.0	.175	.125	.085	.150	.108	.074	.103	.075	.052	.060	.044	.030	.019	.014	.010	
4.0	.168	.112	.069	.144	.097	.060	.099	.067	.042	.057	.039	.025	.018	.013	.008	
5.0	.160	.101	.058	.138	.088	.050	.095	.061	.036	.055	.036	.021	.018	.012	.007	
6.0	.153	.093	.050	.132	.081	.043	.091	.056	.031	.053	.033	.018	.017	.011	.006	
7.0	.146	.086	.044	.126	.075	.038	.087	.052	.027	.050	.031	.016	.016	.010	.005	
8.0	.140	.080	.039	.120	.070	.034	.083	.049	.024	.048	.029	.015	.016	.009	.005	
9.0	.134	.075	.036	.115	.065	.031	.080	.046	.022	.046	.027	.013	.015	.009	.004	
10.0	.128	.071	.033	.110	.062	.029	.077	.043	.021	.045	.026	.012	.014	.008	.004	

C Range: 0 - 360DEG
 C Interval: 30.0DEG
 Test Speed: HIGH
 Temperature:25.3DEG
 Operators:H
 Test Date:2025-07-24

γ Range: 0 - 180DEG
 γ Interval: 1.0DEG
 Test System:EVERFINE GO-2000B_V1 SYSTEM V2.0.404.7
 Humidity:65.0%
 Test Distance:4.430m [K=1.0000]
 Remarks:

UGR(Unified Glare Rating) Table

Test:U:219.36V I:0.7778A P:166.71W PF:0.9771 Freq:50.00Hz Lamp Flux:22214.1x1 lm										
NAME: LSLH-175W					TYPE:			WEIGHT:		
SPEC.:					DIM.:			SERIAL No.:LSLH-170W		
MFR.: LSLH					SUR.:			Shielding Angle:		
ceiling/cavity	0.7	0.7	0.5	0.5	0.3	0.7	0.7	0.5	0.5	0.3
walls	0.5	0.3	0.5	0.3	0.3	0.5	0.3	0.5	0.3	0.3
working plane	0.2	0.2	0.2	0.2	0.2	0.2	0.2	0.2	0.2	0.2
Room dimensions	Viewed crosswise					Viewed endwise				
x = 2H y = 2H	22.9	24.4	23.2	24.6	24.8	22.9	24.4	23.1	24.6	24.8
3H	24.4	25.8	24.7	26.0	26.3	24.4	25.8	24.7	26.0	26.3
4H	25.0	26.3	25.4	26.6	26.9	25.0	26.3	25.3	26.6	26.9
6H	25.5	26.7	25.8	27.0	27.3	25.4	26.6	25.8	26.9	27.3
8H	25.6	26.8	26.0	27.1	27.4	25.5	26.7	25.9	27.0	27.4
12H	25.7	26.8	26.1	27.2	27.5	25.6	26.8	26.0	27.1	27.4
4H 2H	23.5	24.8	23.8	25.1	25.4	23.5	24.8	23.8	25.1	25.4
3H	25.2	26.4	25.6	26.7	27.0	25.2	26.4	25.6	26.7	27.0
4H	26.0	27.0	26.4	27.4	27.7	26.0	27.0	26.4	27.4	27.7
6H	26.6	27.5	27.0	27.9	28.3	26.5	27.5	26.9	27.8	28.2
8H	26.8	27.6	27.2	28.0	28.5	26.7	27.6	27.2	28.0	28.4
12H	26.9	27.7	27.3	28.1	28.5	26.8	27.6	27.3	28.0	28.5
8H 4H	26.3	27.2	26.7	27.6	28.0	26.3	27.1	26.7	27.5	27.9
6H	27.0	27.8	27.5	28.2	28.7	27.0	27.7	27.5	28.2	28.6
8H	27.3	28.0	27.8	28.4	28.9	27.3	27.9	27.8	28.4	28.9
12H	27.5	28.1	28.0	28.6	29.1	27.5	28.1	28.0	28.5	29.0
12H 4H	26.3	27.1	26.8	27.5	28.0	26.3	27.1	26.7	27.5	27.9
6H	27.1	27.8	27.6	28.2	28.7	27.1	27.7	27.6	28.2	28.7
8H	27.5	28.0	28.0	28.5	29.0	27.4	28.0	27.9	28.4	29.0
Variations with the observer position at spacings:										
S = 1.0H	+ 0.1 / - 0.2					+ 0.2 / - 0.2				
1.5H	+ 0.2 / - 0.3					+ 0.2 / - 0.3				
2.0H	+ 0.1 / - 0.3					+ 0.1 / - 0.4				

CIE Pub.117, 19714 lm Total Lamp Luminous Flux Corrected (8log(F/F0) = 10.4)

C Range: 0 - 360DEG	γ Range: 0 - 180DEG
C Interval: 30.0DEG	γ Interval: 1.0DEG
Test Speed: HIGH	Test System:EVERFINE GO-2000B_V1 SYSTEM V2.0.404.7
Temperature:25.3DEG	Humidity:65.0%
Operators:H	Test Distance:4.430m [K=1.0000]
Test Date:2025-07-24	Remarks:

UTILIZATION FACTORS TABLE

Test:U:219.36V I:0.7778A P:166.71W PF:0.9771 Freq:50.00Hz Lamp Flux:22214.1x1 lm		
NAME: LSLH-175W	TYPE:	WEIGHT:
SPEC.:	DIM.:	SERIAL No.:LSLH-170W
MFR.: LSLH	SUR.:	Shielding Angle:

REFLECTANCE										
Ceiling	0.8	0.8	0.8	0.7	0.7	0.7	0.5	0.5	0.5	0
Walls	0.7	0.5	0.3	0.7	0.5	0.3	0.7	0.5	0.3	0
Working plane	0.2	0.2	0.2	0.2	0.2	0.2	0.2	0.2	0.2	0
ROOM INDEX	UTILIZATION FACTORS (PERCENT) $k(RI) \times RCR = 5$									
k = 0.60	57	45	38	56	45	38	55	44	38	31
0.80	67	55	48	66	55	48	64	54	47	40
1.00	75	64	57	74	64	57	72	65	56	49
1.25	82	72	65	81	71	64	78	70	63	56
1.50	87	78	70	86	77	70	83	75	69	61
2.00	94	86	79	92	84	78	89	82	77	69
2.50	98	90	84	96	89	83	92	86	81	73
3.00	102	95	89	99	93	88	95	90	86	77
4.00	106	100	95	103	98	94	99	95	91	82
5.00	108	103	99	106	101	97	101	97	94	85
ROOM INDEX	UF(total)									Direct
According to DIN EN 13032-2 2004			Suspended				SHRNOM = 1.25			

C Range: 0 - 360DEG
C Interval: 30.0DEG
Test Speed: HIGH
Temperature:25.3DEG
Operators:H
Test Date:2025-07-24

γ Range: 0 - 180DEG
 γ Interval: 1.0DEG
Test System:EVERFINE GO-2000B_V1 SYSTEM V2.0.404.7
Humidity:65.0%
Test Distance:4.430m [K=1.0000]
Remarks:

ISOCANDELA DIAGRAM

Test:U:219.36V I:0.7778A P:166.71W PF:0.9771 Freq:50.00Hz Lamp Flux:22214.1x1 lm		
NAME: LSLH-175W	TYPE:	WEIGHT:
SPEC.:	DIM.:	SERIAL No.:LSLH-170W
MFR.: LSLH	SUR.:	Shielding Angle:

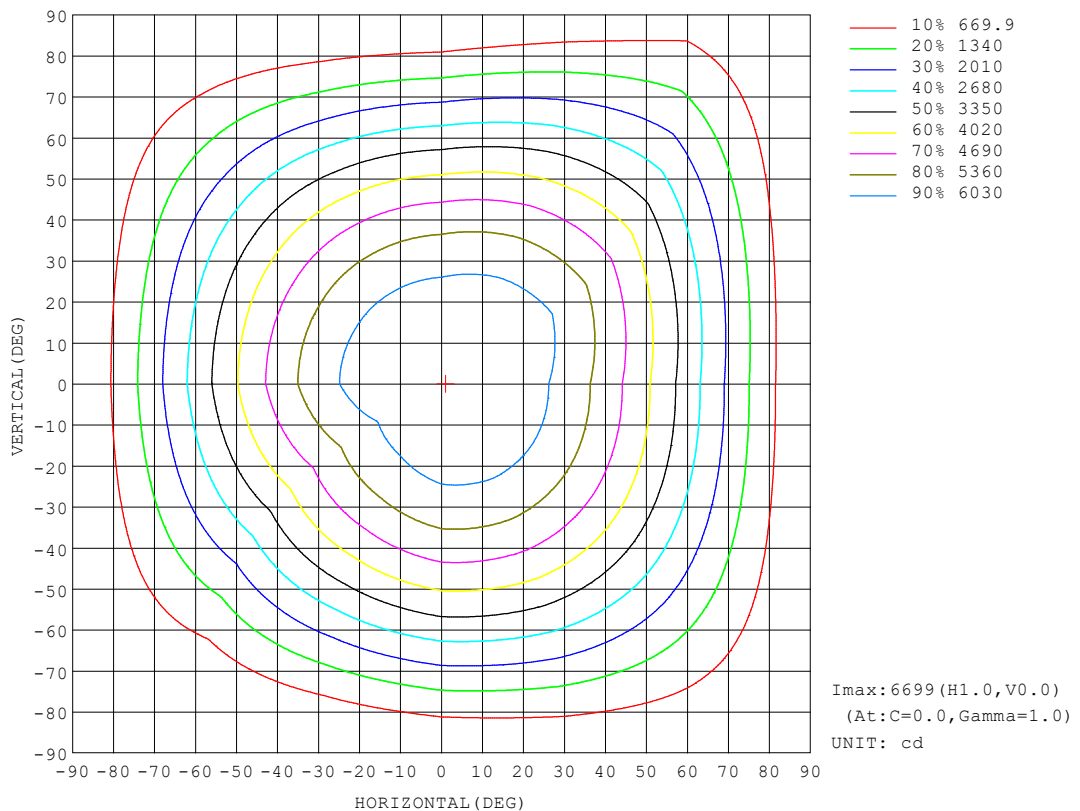

C Range: 0 - 360DEG
C Interval: 30.0DEG
Test Speed: HIGH
Temperature:25.3DEG
Operators:H
Test Date:2025-07-24

γ Range: 0 - 180DEG
 γ Interval: 1.0DEG
Test System:EVERFINE GO-2000B_V1 SYSTEM V2.0.404.7
Humidity:65.0%
Test Distance:4.430m [K=1.0000]
Remarks:

AAI Figure

Test:U:219.36V I:0.7778A P:166.71W PF:0.9771 Freq:50.00Hz Lamp Flux:22214.1x1 lm		
NAME: LSLH-175W	TYPE:	WEIGHT:
SPEC.:	DIM.:	SERIAL No.:LSLH-170W
MFR.: LSLH	SUR.:	Shielding Angle:

Flux out:14394 lm

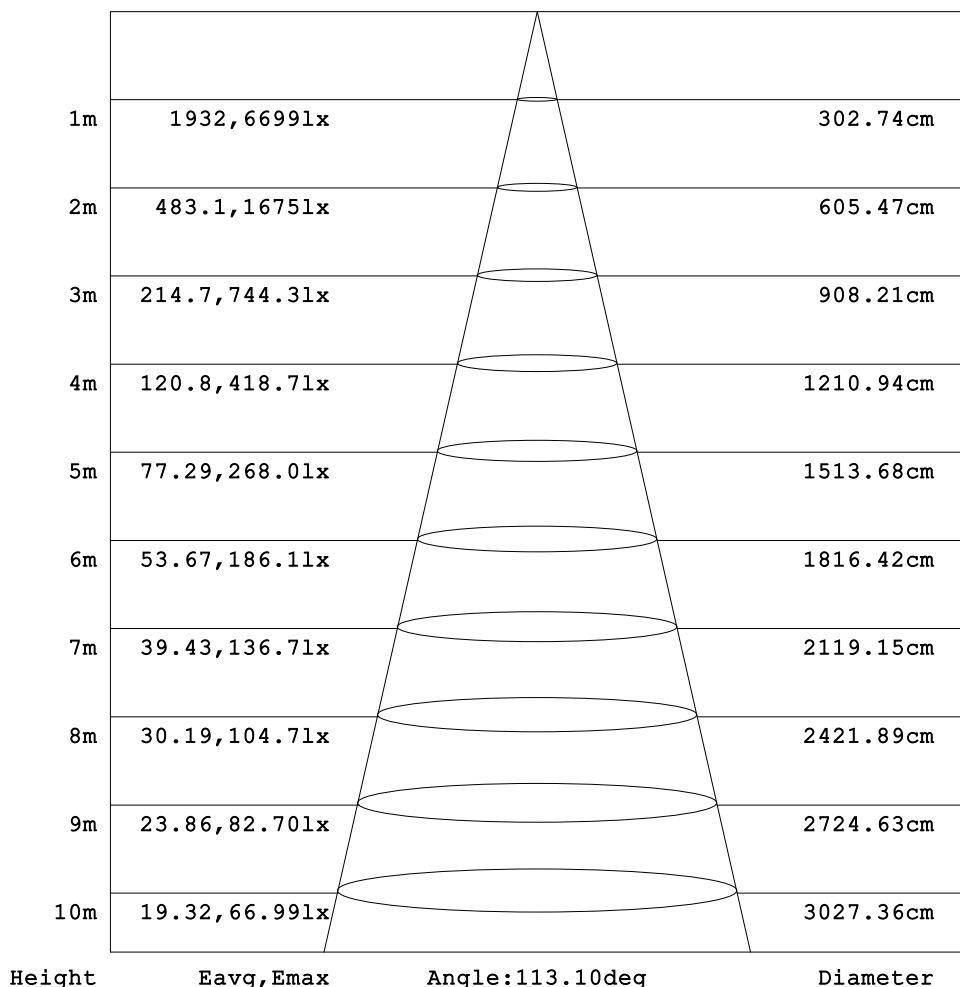

Note:The Curves indicate the illuminated area and the average illumination when the luminaire is at different distance.

C Range: 0 - 360DEG
C Interval: 30.0DEG
Test Speed: HIGH
Temperature:25.3DEG
Operators:H
Test Date:2025-07-24

γ Range: 0 - 180DEG
γ Interval: 1.0DEG
Test System:EVERFINE GO-2000B_V1 SYSTEM V2.0.404.7
Humidity:65.0%
Test Distance:4.430m [K=1.0000]
Remarks:

ISOLUX DIAGRAM

Test:U:219.36V I:0.7778A P:166.71W PF:0.9771 Freq:50.00Hz Lamp Flux:22214.1x1 lm		
NAME: LSLH-175W	TYPE:	WEIGHT:
SPEC.:	DIM.:	SERIAL No.:LSLH-170W
MFR.: LSLH	SUR.:	Shielding Angle:

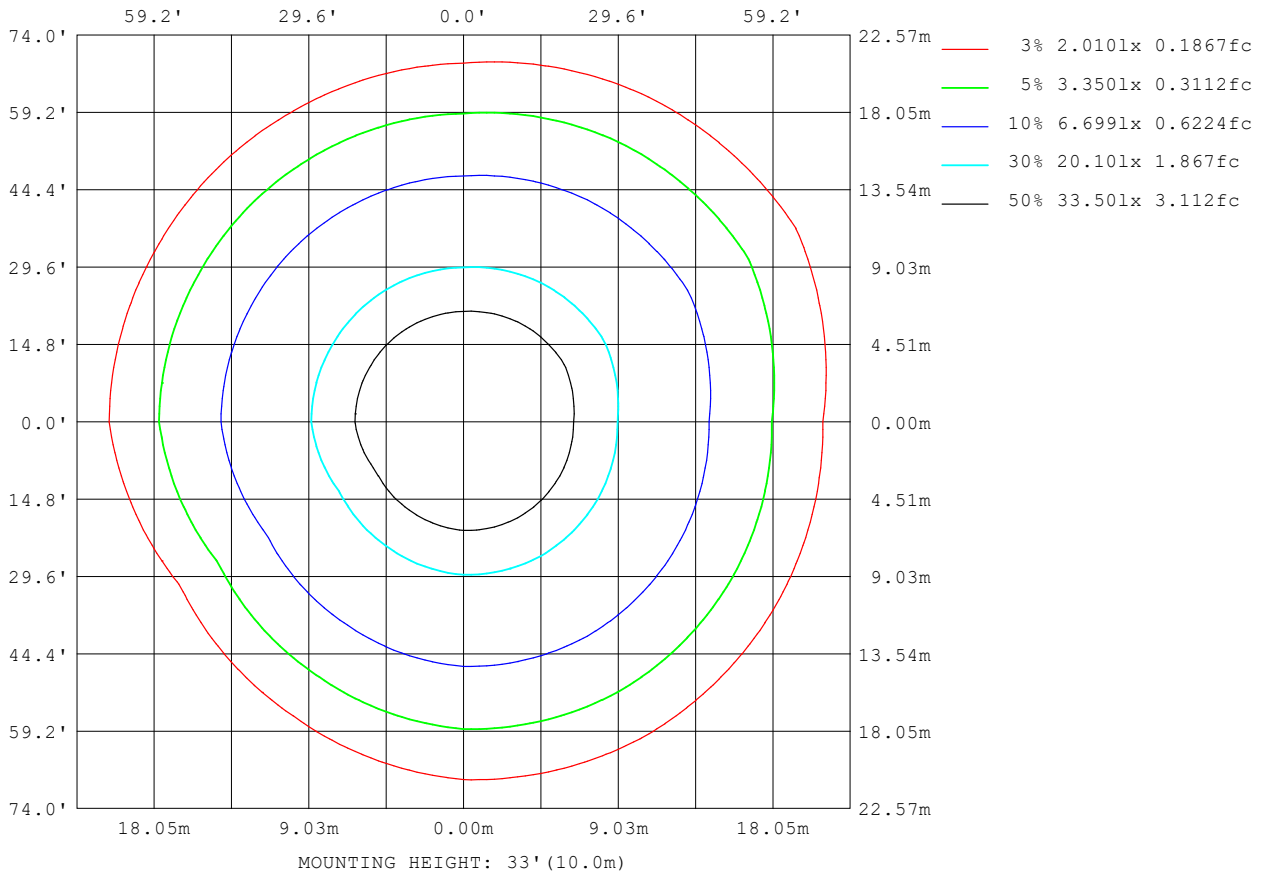

C Range: 0 - 360DEG
 C Interval: 30.0DEG
 Test Speed: HIGH
 Temperature:25.3DEG
 Operators:H
 Test Date:2025-07-24

γ Range: 0 - 180DEG
 γ Interval: 1.0DEG
 Test System:EVERFINE GO-2000B_V1 SYSTEM V2.0.404.7
 Humidity:65.0%
 Test Distance:4.430m [K=1.0000]
 Remarks:

LED Avg.L Report

Test:U:219.36V I:0.7778A P:166.71W PF:0.9771 Freq:50.00Hz Lamp Flux:22214.1x1 lm		
NAME: LSLH-175W	TYPE:	WEIGHT:
SPEC.:	DIM.:	SERIAL No.:LSLH-170W
MFR.: LSLH	SUR.:	Shielding Angle:

AvgL	cd/m2
L_0~180 (65) av	15938
L_0~180 (75) av	14042
L_0~180 (85) av	9656
L_90~270 (65) av	16125
L_90~270 (75) av	14101
L_90~270 (85) av	9674
L_45 (65) av	16047
L_45 (75) av	14193
L_45 (85) av	11256

Standard: GB/T 29293-2012

C Range: 0 - 360DEG
 C Interval: 30.0DEG
 Test Speed: HIGH
 Temperature:25.3DEG
 Operators:H
 Test Date:2025-07-24

γ Range: 0 - 180DEG
 γ Interval: 1.0DEG
 Test System:EVERFINE GO-2000B_V1 SYSTEM V2.0.404.7
 Humidity:65.0%
 Test Distance:4.430m [K=1.0000]
 Remarks:

Planar Illuminance Curve

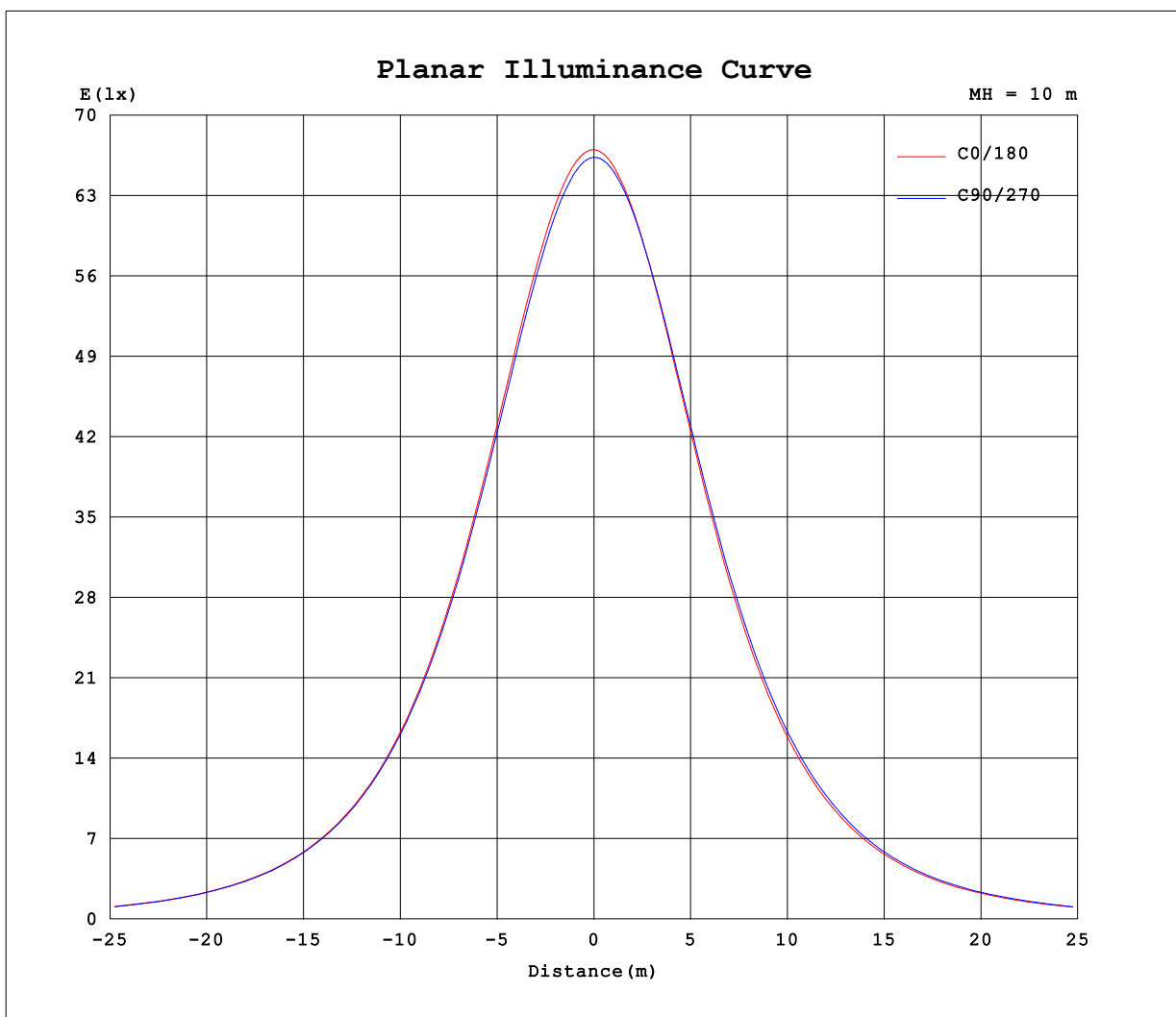

C Range: 0 - 360DEG
 C Interval: 30.0DEG
 Test Speed: HIGH
 Temperature: 25.3DEG
 Operators: H
 Test Date: 2025-07-24

γ Range: 0 - 180DEG
 γ Interval: 1.0DEG
 Test System: EVERFINE GO-2000B_V1 SYSTEM V2.0.404.7
 Humidity: 65.0%
 Test Distance: 4.430m [K=1.0000]
 Remarks:

LUMINOUS DISTRIBUTION INTENSITY DATA

Test:U:219.36V I:0.7778A P:166.71W PF:0.9771 Freq:50.00Hz Lamp Flux:22214.1x1 lm		
NAME: LSLH-175W	TYPE:	WEIGHT:
SPEC.:	DIM.:	SERIAL No.:LSLH-170W
MFR.: LSLH	SUR.:	Shielding Angle:

Table--1

UNIT: cd

C (DEG) \ γ (DEG)	0	30	60	90	120	150	180	210	240	270	300	330							
0	6699	6689	6666	6633	6602	6604	6699	6689	6666	6633	6602	6604							
5	6681	6672	6645	6601	6534	6511	6667	6658	6641	6620	6624	6648							
10	6613	6606	6578	6525	6418	6368	6586	6577	6569	6561	6599	6644							
15	6494	6491	6465	6401	6254	6173	6452	6445	6446	6454	6526	6590							
20	6321	6324	6301	6228	6038	5924	6265	6259	6271	6294	6404	6487							
25	6090	6103	6084	6002	5768	5619	6022	6016	6040	6079	6227	6329							
30	5803	5824	5813	5721	5444	5260	5720	5714	5748	5804	5990	6114							
35	5455	5487	5483	5384	5064	4850	5362	5354	5397	5468	5693	5839							
40	5054	5097	5100	4992	4636	4393	4950	4939	4992	5073	5335	5505							
45	4604	4655	4665	4551	4165	3899	4489	4474	4529	4622	4918	5112							
50	4108	4168	4182	4063	3654	3375	3989	3968	4021	4123	4450	4668							
55	3580	3646	3664	3540	3119	2830	3459	3430	3478	3586	3937	4177							
60	3027	3096	3117	2990	2565	2276	2906	2870	2910	3020	3388	3648							
65	2462	2534	2552	2426	2007	1727	2346	2300	2333	2439	2816	3091							
70	1898	1969	1985	1861	1460	1197	1788	1734	1757	1858	2235	2520							
75	1348	1416	1430	1310	938	694	1246	1188	1202	1295	1661	1948							
80	821	888	899	791	457	238	734	673	680	763	1108	1388							
85	338	400	413	320	66.9	19.8	263	205	207	282	592	853							
90	19.1	18.6	45.8	19.2	21.3	22.4	20.2	20.8	20.2	20.0	133	362							
95	21.2	20.8	20.7	21.4	24.2	25.8	22.8	23.5	22.5	22.0	20.9	20.4							
100	24.5	23.9	23.5	24.5	27.5	29.4	26.4	26.9	25.5	24.9	23.2	22.1							
105	28.3	27.5	26.9	28.1	31.1	33.0	30.3	30.6	29.0	28.4	26.2	25.4							
110	33.1	32.0	31.3	32.4	35.8	37.7	34.9	35.1	33.2	32.5	30.4	29.8							
115	38.6	37.3	36.4	37.5	41.3	43.3	39.9	40.1	38.0	36.9	35.1	34.5							
120	43.5	41.8	40.9	41.6	45.4	48.1	44.6	44.8	42.5	41.1	39.5	38.8							
125	47.7	45.7	44.8	44.9	48.9	52.6	48.0	48.3	45.3	43.8	42.8	42.0							
130	51.1	49.1	47.8	47.9	51.7	56.0	51.2	51.6	47.7	46.2	45.5	44.8							
135	53.9	52.2	50.3	50.3	53.9	58.0	54.1	54.4	49.9	48.6	47.8	47.5							
140	56.6	54.9	52.9	52.7	56.0	58.9	56.4	56.0	52.0	50.9	50.4	50.5							
145	58.6	57.5	55.8	55.0	58.1	60.2	58.5	56.1	54.3	53.2	53.2	53.3							
150	61.2	60.4	58.8	57.6	60.6	59.6	61.1	57.3	56.5	55.8	55.9	56.1							
155	63.8	63.7	62.0	60.5	62.8	61.3	63.7	57.7	59.0	58.7	59.0	59.2							
160	66.6	67.3	64.6	62.4	64.9	66.5	66.8	62.2	61.6	61.3	62.1	62.8							
165	69.2	70.3	66.5	64.0	66.5	68.7	70.4	67.2	64.2	63.4	64.7	66.4							
170	71.4	71.7	67.2	65.2	67.3	70.2	73.8	69.4	66.2	65.2	66.2	69.1							
175	70.0	68.8	64.6	63.2	64.4	67.8	71.9	68.9	65.3	64.3	65.0	68.1							
180	66.1	64.6	61.0	59.8	60.3	63.3	66.1	64.5	61.0	59.9	60.3	63.3							

C Range: 0 - 360DEG
C Interval: 30.0DEG
Test Speed: HIGH
Temperature:25.3DEG
Operators:H
Test Date:2025-07-24

γ Range: 0 - 180DEG
γ Interval: 1.0DEG
Test System:EVERFINE GO-2000B_V1 SYSTEM V2.0.404.7
Humidity:65.0%
Test Distance:4.430m [K=1.0000]
Remarks:

LUMINAIRE PHOTOMETRIC TEST REPORT

Test:U:219.47V I:0.1673A P:21.605W PF:0.5883 Freq:50.00Hz Lamp Flux:2757.01x1 lm		
NAME: LSLH-10%	TYPE: LSLH-10%	WEIGHT:
SPEC.:	DIM.:	SERIAL No.: LSLH-10%
MFR.: LSLH	SUR.:	Shielding Angle:

DATA OF LAMP		PHOTOMETRIC DATA				Eff: 127.61 lm/W
MODEL	LSLH-10%	I _{max} (cd)	730.0	S/MH (C0/180)		1.23
NOMINAL POWER (W)	17	LOR (%)	100.0	S/MH (C90/270)		1.29
RATED VOLTAGE (V)	220	TOTAL FLUX (lm)	2757	η UP, DN (C0-180)		0.7, 48.6
NOMINAL FLUX (lm)	2757.01	CIE CLASS	DIRECT	η UP, DN (C180-360)		0.8, 49.9
LAMPS INSIDE	1	η up (%)	1.6	CIBSE SHR NOM		1.25
TEST VOLTAGE (V)	220	η down (%)	98.4	CIBSE SHR MAX		1.35

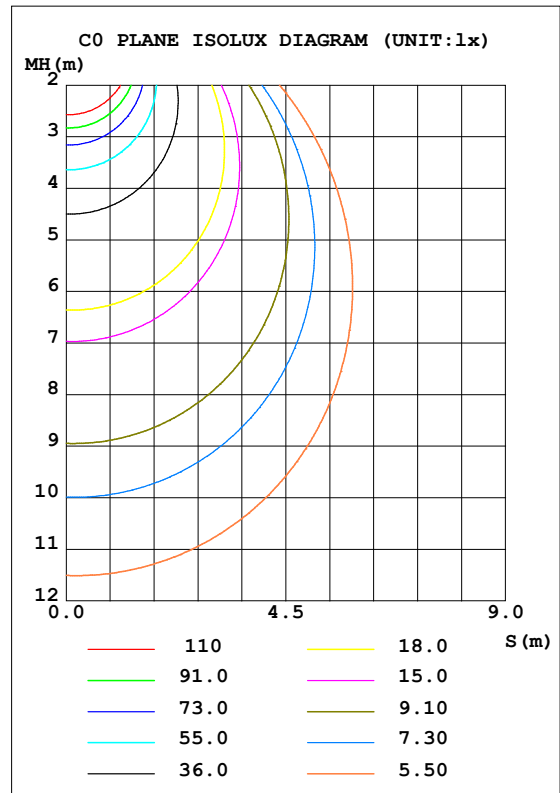
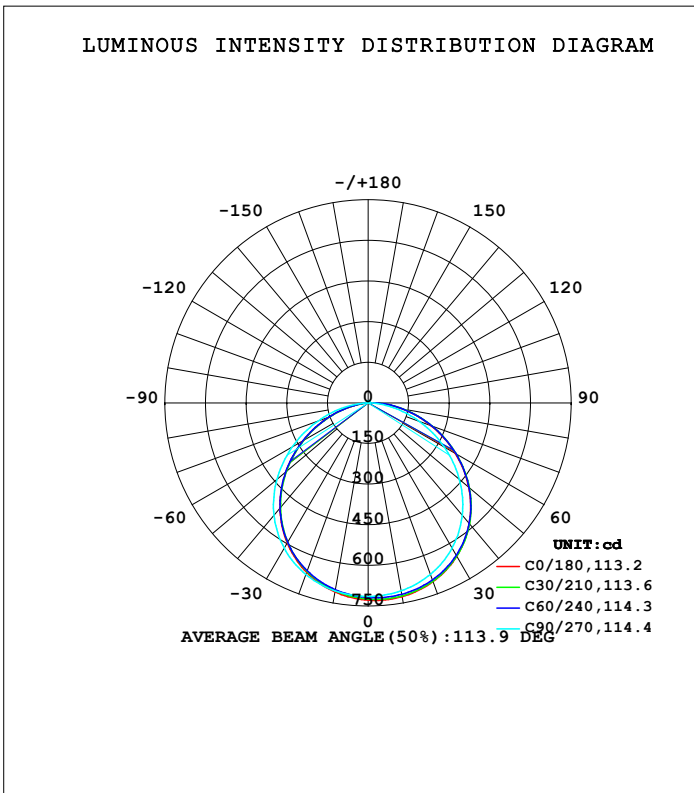

C Range: 0 - 360DEG
C Interval: 30.0DEG
Test Speed: HIGH
Temperature: 25.3DEG
Operators: C
Test Date: 2026-01-29

γ Range: 0 - 180DEG
γ Interval: 1.0DEG
Test System: EVERFINE GO-2000B_V1 SYSTEM V2.0.404.7
Humidity: 65.0%
Test Distance: 4.430m [K=1.0000]
Remarks:

ZONAL FLUX DIAGRAM

ZONAL FLUX DIAGRAM:

γ	C0	C45	C90	C135	C180	C225	C270	C315	γ	Φ zone	Φ total	%lum,lamp
10	726.1	720.1	704.2	683.7	708.4	702.0	704.3	719.2	0- 10	68.06	68.06	3.17,3.17
20	702.0	697.7	673.4	632.4	665.4	660.3	673.8	705.4	10- 20	196.1	264.2	12.3,12.3
30	654.2	652.2	619.3	557.6	597.6	594.4	619.8	669.2	20- 30	299.9	564.0	26.3,26.3
40	581.1	581.7	540.8	461.1	506.2	504.7	541.1	608.2	30- 40	364.5	928.5	43.3,43.3
50	484.7	487.3	440.2	348.6	396.2	395.5	439.7	522.1	40- 50	379.2	1308	61,61
60	371.0	374.5	323.8	228.9	276.0	274.8	322.2	414.8	50- 60	341.7	1649	76.9,76.9
70	248.3	252.1	202.0	112.4	155.3	152.8	197.9	293.8	60- 70	260.0	1909	89,89
80	127.6	131.5	86.13	15.81	44.88	41.88	80.34	170.0	70- 80	151.6	2061	96.1,96.1
90	20.77	24.73	2.271	2.679	2.397	2.476	2.320	55.93	80- 90	50.77	2112	98.4,98.4
100	2.524	2.559	2.872	3.436	3.282	3.306	3.000	2.569	90-100	6.604	2118	98.8,98.8
110	3.419	3.391	3.727	4.317	4.142	4.142	3.796	3.262	100-110	3.547	2122	98.9,98.9
120	4.463	4.385	4.666	5.323	5.067	5.073	4.642	4.142	110-120	4.214	2126	99.1,99.1
130	5.337	5.229	5.395	6.084	5.871	5.837	5.327	4.924	120-130	4.602	2131	99.3,99.3
140	6.008	5.896	5.976	6.487	6.361	6.280	5.846	5.512	130-140	4.480	2135	99.5,99.5
150	6.544	6.536	6.539	6.785	6.875	6.491	6.387	6.139	140-150	3.942	2139	99.7,99.7
160	7.188	7.232	7.041	7.376	7.539	7.159	6.977	6.859	150-160	3.155	2142	99.9,99.9
170	7.736	7.643	7.305	7.691	8.218	7.717	7.346	7.447	160-170	2.104	2144	100,100
180	7.408	7.078	6.745	6.934	7.425	7.081	6.733	6.941	170-180	0.7141	2145	100,100
DEG	LUMINOUS INTENSITY:cd									UNIT:lm		

C Range: 0 - 360DEG
 C Interval: 30.0DEG
 Test Speed: HIGH
 Temperature:25.3DEG
 Operators:C
 Test Date:2026-01-29

γ Range: 0 - 180DEG
 γ Interval: 1.0DEG
 Test System:EVERFINE GO-2000B_V1 SYSTEM V2.0.404.7
 Humidity:65.0%
 Test Distance:4.430m [K=1.0000]
 Remarks:

LUMINANCE LIMITATION CURVES

Test:U:219.47V I:0.1673A P:21.605W PF:0.5883 Freq:50.00Hz Lamp Flux:2757.01x1 lm		
NAME: LSLH-10%	TYPE:LSLH-10%	WEIGHT:
SPEC.:	DIM.:	SERIAL No.:LSLH-10%
MFR.: LSLH	SUR.:	Shielding Angle:

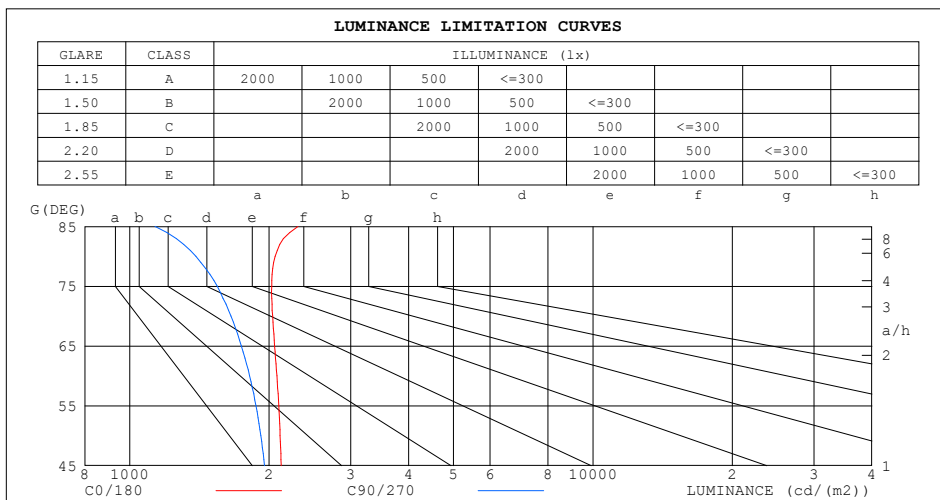

LUMINANCE cd/(m2)		
G (DEG)	C0/180	C90/270
85	2308	1134
80	2059	1390
75	2026	1544
70	2035	1654
65	2056	1743
60	2079	1815
55	2099	1873
50	2113	1919
45	2123	1954

C Range: 0 - 360DEG
 C Interval: 30.0DEG
 Test Speed: HIGH
 Temperature:25.3DEG
 Operators:C
 Test Date:2026-01-29

γ Range: 0 - 180DEG
 γ Interval: 1.0DEG
 Test System:EVERFINE GO-2000B_V1 SYSTEM V2.0.404.7
 Humidity:65.0%
 Test Distance:4.430m [K=1.0000]
 Remarks:

CU AND LUMINAIRE BUDGETARY ESTIMATE DIAGRAM

Test:U:219.47V I:0.1673A P:21.605W PF:0.5883 Freq:50.00Hz Lamp Flux:2757.01x1 lm		
NAME: LSLH-10%	TYPE:LSLH-10%	WEIGHT:
SPEC.:	DIM.:	SERIAL No.:LSLH-10%
MFR.: LSLH	SUR.:	Shielding Angle:

ρ_{cc}	80%			70%			50%			30%			10%			0
ρ_w	50%	30%	10%	50%	30%	10%	50%	30%	10%	50%	30%	10%	50%	30%	10%	0
ρ_{fc}	20%			20%			20%			20%			20%			0
RCR	RCR:Room Cavity Ratio						Coefficients of Utilization (CU)									
0.0	1.19	1.19	1.19	1.16	1.16	1.16	1.10	1.10	1.10	1.05	1.05	1.05	1.01	1.01	1.01	.98
1.0	1.03	.99	.95	1.01	.97	.93	.96	.93	.90	.92	.89	.87	.88	.86	.84	.82
2.0	.90	.83	.77	.88	.81	.76	.84	.79	.74	.80	.76	.72	.77	.73	.70	.68
3.0	.79	.70	.64	.77	.69	.63	.74	.67	.62	.71	.65	.61	.68	.63	.59	.57
4.0	.70	.61	.54	.68	.60	.53	.65	.58	.53	.63	.57	.52	.61	.55	.51	.49
5.0	.62	.53	.46	.61	.52	.46	.59	.51	.45	.56	.50	.45	.54	.49	.44	.42
6.0	.56	.47	.40	.55	.46	.40	.53	.45	.40	.51	.44	.39	.49	.43	.39	.37
7.0	.51	.42	.36	.50	.41	.35	.48	.41	.35	.46	.40	.35	.45	.39	.34	.32
8.0	.46	.38	.32	.45	.37	.32	.44	.37	.31	.43	.36	.31	.41	.35	.31	.29
9.0	.42	.34	.28	.42	.34	.28	.40	.33	.28	.39	.33	.28	.38	.32	.28	.26
10.0	.39	.31	.26	.38	.31	.26	.37	.30	.25	.36	.30	.25	.35	.29	.25	.23

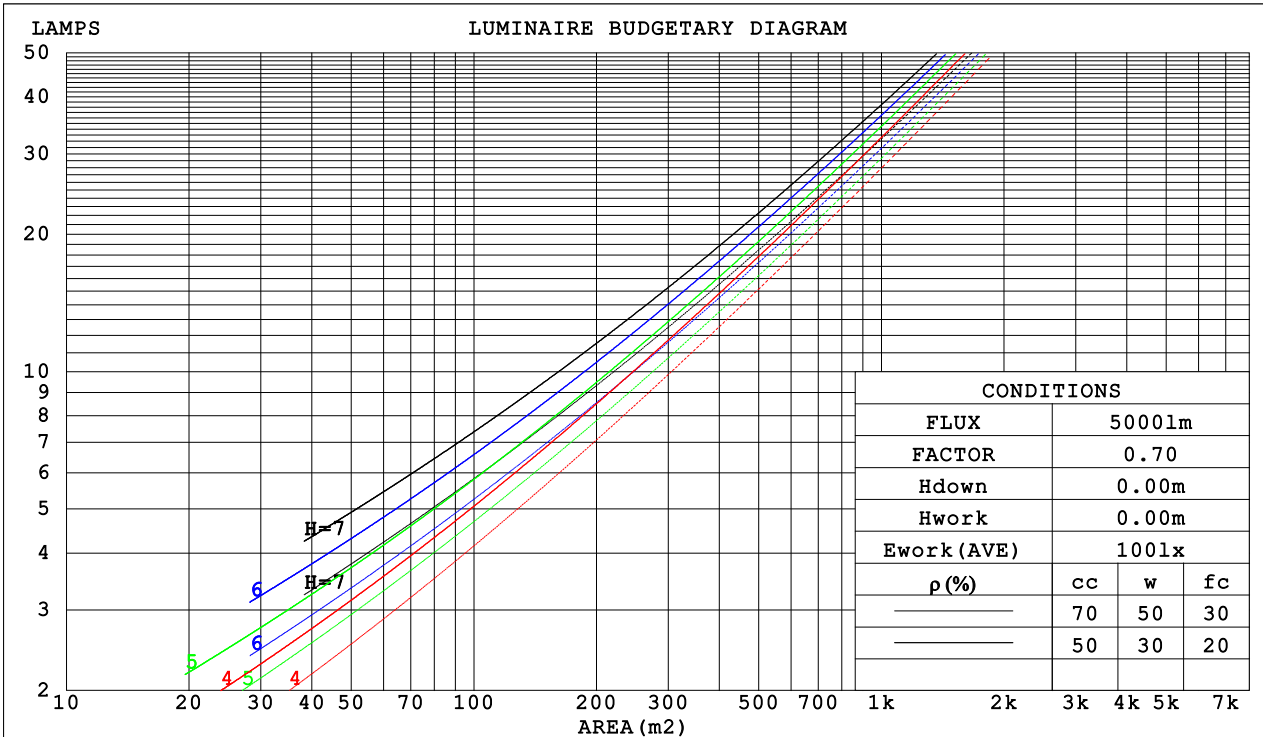

C Range: 0 - 360DEG
 C Interval: 30.0DEG
 Test Speed: HIGH
 Temperature:25.3DEG
 Operators:C
 Test Date:2026-01-29

γ Range: 0 - 180DEG
 γ Interval: 1.0DEG
 Test System:EVERFINE GO-2000B_V1 SYSTEM V2.0.404.7
 Humidity:65.0%
 Test Distance:4.430m [K=1.0000]
 Remarks:

WEC AND CCEC

Test:U:219.47V I:0.1673A P:21.605W PF:0.5883 Freq:50.00Hz Lamp Flux:2757.01x1 lm		
NAME: LSLH-10%	TYPE:LSLH-10%	WEIGHT:
SPEC.:	DIM.:	SERIAL No.:LSLH-10%
MFR.: LSLH	SUR.:	Shielding Angle:

ρcc	80%			70%			50%			30%			10%			0
ρw	50%	30%	10%	50%	30%	10%	50%	30%	10%	50%	30%	10%	50%	30%	10%	0
ρfc	20%			20%			20%			20%			20%			0
RCR	RCR:Room Cavity Ratio						Wall Exitance Coefficients (WEC)									
0.0																
1.0	.315	.179	.057	.308	.176	.056	.294	.169	.054	.281	.162	.052	.269	.156	.050	
2.0	.295	.161	.050	.288	.159	.049	.275	.153	.048	.264	.148	.046	.253	.143	.045	
3.0	.272	.145	.043	.266	.142	.043	.255	.138	.042	.244	.134	.041	.235	.130	.040	
4.0	.250	.130	.038	.245	.128	.038	.235	.125	.037	.226	.121	.037	.218	.118	.036	
5.0	.231	.118	.034	.227	.116	.034	.218	.113	.033	.210	.111	.033	.202	.108	.032	
6.0	.214	.107	.031	.210	.106	.031	.202	.104	.030	.195	.101	.030	.188	.099	.029	
7.0	.199	.099	.028	.196	.097	.028	.189	.095	.027	.182	.093	.027	.176	.091	.027	
8.0	.186	.091	.026	.183	.090	.025	.176	.088	.025	.170	.086	.025	.165	.085	.025	
9.0	.174	.084	.024	.171	.083	.023	.166	.082	.023	.160	.080	.023	.155	.079	.023	
10.0	.164	.079	.022	.161	.078	.022	.156	.076	.022	.151	.075	.021	.146	.074	.021	

ρcc	80%			70%			50%			30%			10%			0
ρw	50%	30%	10%	50%	30%	10%	50%	30%	10%	50%	30%	10%	50%	30%	10%	0
ρfc	20%			20%			20%			20%			20%			0
RCR	RCR:Room Cavity Ratio						Ceiling Cavity Exitance Coefficients (CCEC)									
0.0	.202	.202	.202	.173	.173	.173	.118	.118	.118	.068	.068	.068	.022	.022	.022	
1.0	.193	.168	.146	.165	.144	.126	.113	.099	.087	.065	.057	.050	.021	.018	.016	
2.0	.185	.144	.110	.158	.124	.095	.108	.086	.066	.062	.050	.039	.020	.016	.013	
3.0	.177	.126	.086	.152	.109	.075	.104	.076	.052	.060	.044	.031	.019	.014	.010	
4.0	.169	.113	.070	.145	.098	.061	.100	.068	.043	.058	.040	.025	.019	.013	.008	
5.0	.162	.103	.059	.139	.089	.052	.096	.062	.036	.055	.036	.022	.018	.012	.007	
6.0	.155	.094	.051	.133	.082	.045	.092	.057	.032	.053	.034	.019	.017	.011	.006	
7.0	.148	.088	.045	.127	.076	.040	.088	.053	.028	.051	.031	.017	.016	.010	.006	
8.0	.141	.082	.041	.122	.071	.036	.084	.050	.025	.049	.029	.015	.016	.010	.005	
9.0	.135	.077	.037	.117	.067	.033	.081	.047	.023	.047	.028	.014	.015	.009	.005	
10.0	.130	.073	.035	.112	.063	.030	.078	.044	.022	.045	.026	.013	.015	.009	.004	

C Range: 0 - 360DEG
 C Interval: 30.0DEG
 Test Speed: HIGH
 Temperature:25.3DEG
 Operators:C
 Test Date:2026-01-29

γ Range: 0 - 180DEG
 γ Interval: 1.0DEG
 Test System:EVERFINE GO-2000B_V1 SYSTEM V2.0.404.7
 Humidity:65.0%
 Test Distance:4.430m [K=1.0000]
 Remarks:

UGR(Unified Glare Rating) Table

Test:U:219.47V I:0.1673A P:21.605W PF:0.5883 Freq:50.00Hz Lamp Flux:2757.01x1 lm										
NAME: LSLH-10%				TYPE:LSLH-10%				WEIGHT:		
SPEC.:				DIM.:				SERIAL No.:LSLH-10%		
MFR.: LSLH				SUR.:				Shielding Angle:		
ceiling/cavity	0.7	0.7	0.5	0.5	0.3	0.7	0.7	0.5	0.5	0.3
walls	0.5	0.3	0.5	0.3	0.3	0.5	0.3	0.5	0.3	0.3
working plane	0.2	0.2	0.2	0.2	0.2	0.2	0.2	0.2	0.2	0.2
Room dimensions	Viewed crosswise					Viewed endwise				
x = 2H y = 2H	15.8	17.3	16.1	17.6	17.8	15.5	17.0	15.8	17.2	17.5
3H	17.5	18.9	17.9	19.2	19.5	17.0	18.4	17.3	18.7	18.9
4H	18.3	19.6	18.6	19.9	20.2	17.6	18.9	18.0	19.2	19.5
6H	19.0	20.2	19.3	20.5	20.8	18.1	19.3	18.4	19.6	19.9
8H	19.2	20.4	19.6	20.7	21.1	18.2	19.4	18.6	19.7	20.0
12H	19.4	20.6	19.8	20.9	21.3	18.3	19.4	18.7	19.8	20.1
4H 2H	16.5	17.8	16.8	18.1	18.4	16.2	17.6	16.6	17.9	18.1
3H	18.4	19.6	18.8	19.9	20.2	18.0	19.2	18.4	19.5	19.9
4H	19.3	20.4	19.7	20.7	21.1	18.8	19.9	19.2	20.2	20.6
6H	20.1	21.1	20.6	21.5	21.9	19.4	20.4	19.8	20.7	21.1
8H	20.5	21.3	20.9	21.7	22.2	19.6	20.5	20.1	20.9	21.3
12H	20.8	21.6	21.2	22.0	22.4	19.8	20.6	20.2	21.0	21.4
8H 4H	19.7	20.6	20.1	21.0	21.4	19.2	20.1	19.7	20.5	20.9
6H	20.7	21.4	21.2	21.9	22.3	20.1	20.8	20.6	21.3	21.7
8H	21.2	21.8	21.6	22.3	22.7	20.4	21.1	20.9	21.5	22.0
12H	21.6	22.1	22.1	22.6	23.1	20.7	21.3	21.2	21.7	22.2
12H 4H	19.7	20.5	20.2	20.9	21.4	19.3	20.1	19.8	20.5	21.0
6H	20.8	21.4	21.3	21.9	22.4	20.2	20.9	20.7	21.3	21.8
8H	21.3	21.9	21.8	22.4	22.9	20.7	21.2	21.2	21.7	22.2
Variations with the observer position at spacings:										
S = 1.0H	+ 0.1 / - 0.2					+ 0.1 / - 0.2				
1.5H	+ 0.2 / - 0.3					+ 0.2 / - 0.4				
2.0H	+ 0.1 / - 0.3					+ 0.2 / - 0.5				

CIE Pub.117, 2145 lm Total Lamp Luminous Flux Corrected (8log(F/F0) = 2.7)

C Range: 0 - 360DEG	γ Range: 0 - 180DEG
C Interval: 30.0DEG	γ Interval: 1.0DEG
Test Speed: HIGH	Test System:EVERFINE GO-2000B_V1 SYSTEM V2.0.404.7
Temperature:25.3DEG	Humidity:65.0%
Operators:C	Test Distance:4.430m [K=1.0000]
Test Date:2026-01-29	Remarks:

UTILIZATION FACTORS TABLE

Test:U:219.47V I:0.1673A P:21.605W PF:0.5883 Freq:50.00Hz Lamp Flux:2757.01x1 lm		
NAME: LSLH-10%	TYPE: LSLH-10%	WEIGHT:
SPEC.:	DIM.:	SERIAL No.: LSLH-10%
MFR.: LSLH	SUR.:	Shielding Angle:

REFLECTANCE										
Ceiling	0.8	0.8	0.8	0.7	0.7	0.7	0.5	0.5	0.5	0
Walls	0.7	0.5	0.3	0.7	0.5	0.3	0.7	0.5	0.3	0
Working plane	0.2	0.2	0.2	0.2	0.2	0.2	0.2	0.2	0.2	0
ROOM INDEX	UTILIZATION FACTORS (PERCENT) $k(RI) \times RCR = 5$									
k = 0.60	57	45	38	56	45	38	55	44	38	31
0.80	67	55	48	66	55	47	64	54	47	40
1.00	75	64	56	74	63	56	71	65	56	48
1.25	82	72	64	81	71	64	78	69	63	55
1.50	87	77	70	85	76	69	82	74	68	60
2.00	94	85	79	92	84	78	88	82	76	68
2.50	98	90	84	96	89	83	92	86	81	72
3.00	101	94	89	99	93	88	95	90	85	76
4.00	105	100	95	103	98	93	98	94	90	81
5.00	108	103	99	105	101	97	101	97	94	84
ROOM INDEX	UF(total)									Direct
According to DIN EN 13032-2 2004			Suspended				SHRNOM = 1.25			

C Range: 0 - 360DEG
C Interval: 30.0DEG
Test Speed: HIGH
Temperature: 25.3DEG
Operators: C
Test Date: 2026-01-29

γ Range: 0 - 180DEG
 γ Interval: 1.0DEG
Test System: EVERFINE GO-2000B_V1 SYSTEM V2.0.404.7
Humidity: 65.0%
Test Distance: 4.430m [K=1.0000]
Remarks:

ISOCANDELA DIAGRAM

Test:U:219.47V I:0.1673A P:21.605W PF:0.5883 Freq:50.00Hz Lamp Flux:2757.01x1 lm		
NAME: LSLH-10%	TYPE:LSLH-10%	WEIGHT:
SPEC.:	DIM.:	SERIAL No.:LSLH-10%
MFR.: LSLH	SUR.:	Shielding Angle:

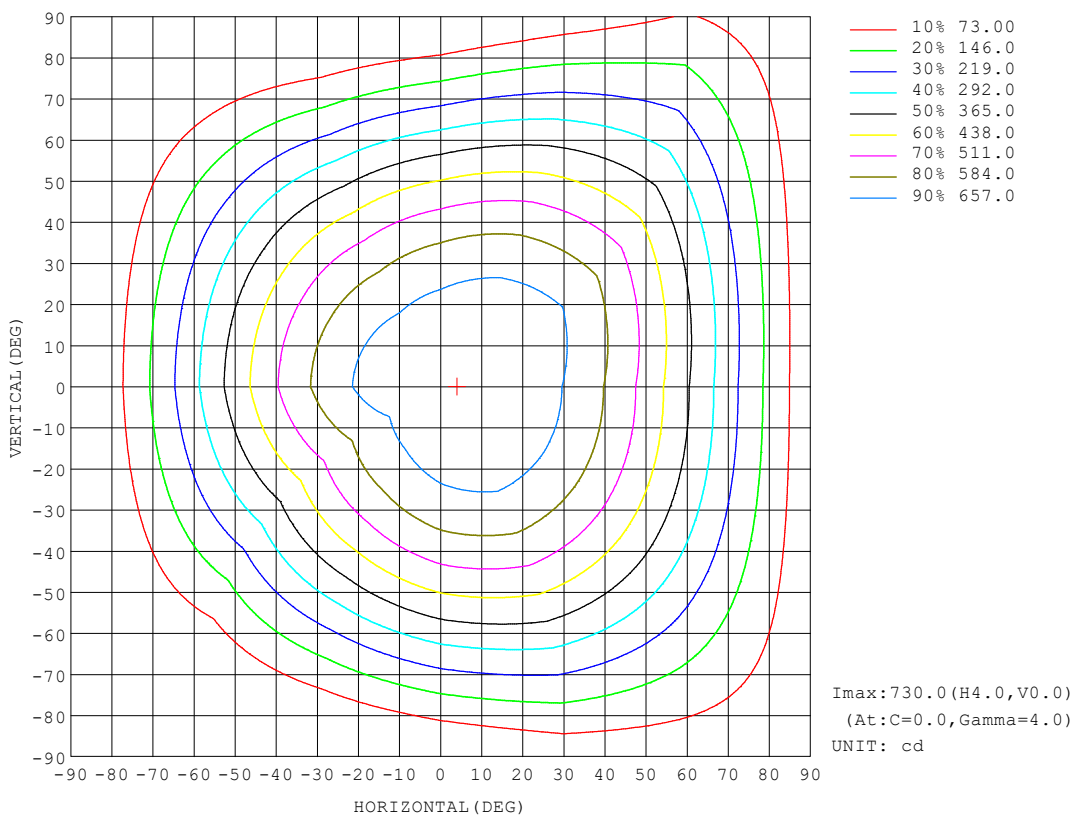

C Range: 0 - 360DEG
 C Interval: 30.0DEG
 Test Speed: HIGH
 Temperature:25.3DEG
 Operators:C
 Test Date:2026-01-29

γ Range: 0 - 180DEG
 γ Interval: 1.0DEG
 Test System:EVERFINE GO-2000B_V1 SYSTEM V2.0.404.7
 Humidity:65.0%
 Test Distance:4.430m [K=1.0000]
 Remarks:

AAI Figure

Test:U:219.47V I:0.1673A P:21.605W PF:0.5883 Freq:50.00Hz Lamp Flux:2757.01x1 lm		
NAME: LSLH-10%	TYPE:LSLH-10%	WEIGHT:
SPEC.:	DIM.:	SERIAL No.:LSLH-10%
MFR.: LSLH	SUR.:	Shielding Angle:

Flux out:1554 lm

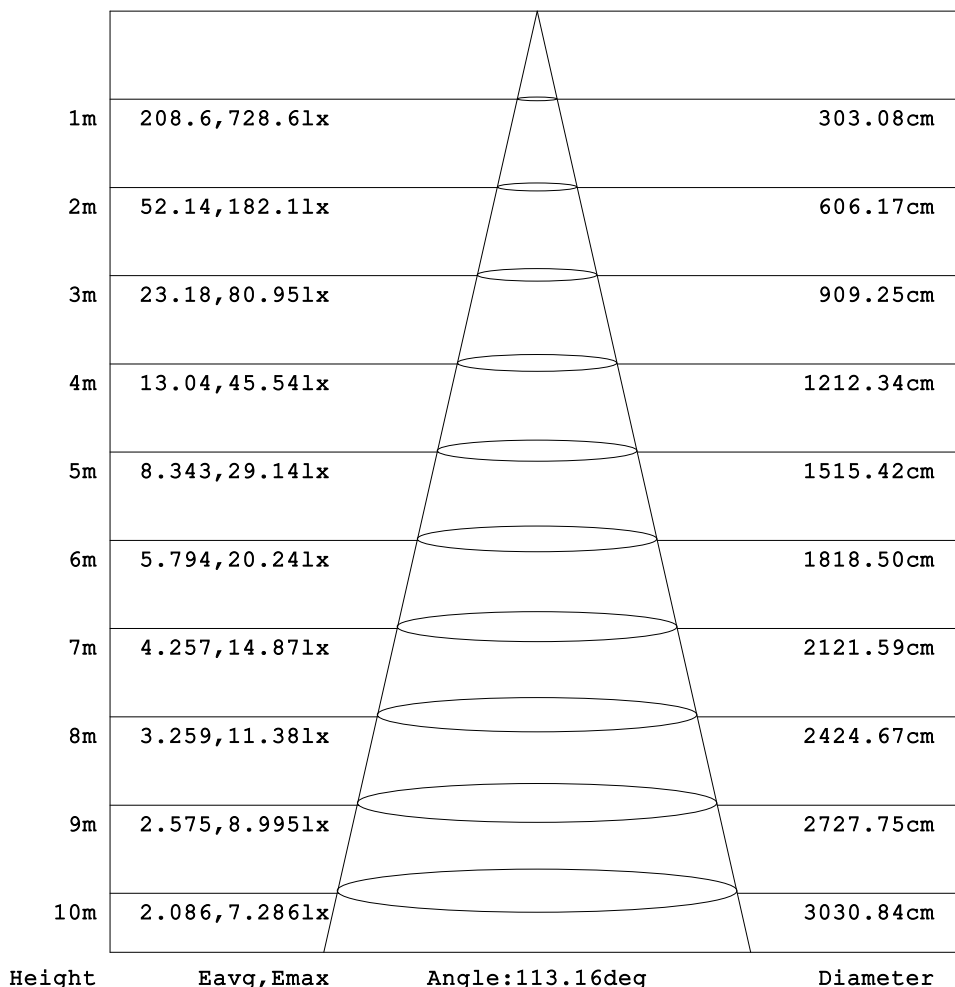

Note:The Curves indicate the illuminated area and the average illumination when the luminaire is at different distance.

C Range: 0 - 360DEG
C Interval: 30.0DEG
Test Speed: HIGH
Temperature:25.3DEG
Operators:C
Test Date:2026-01-29

γ Range: 0 - 180DEG
γ Interval: 1.0DEG
Test System:EVERFINE GO-2000B_V1 SYSTEM V2.0.404.7
Humidity:65.0%
Test Distance:4.430m [K=1.0000]
Remarks:

ISOLUX DIAGRAM

Test:U:219.47V I:0.1673A P:21.605W PF:0.5883 Freq:50.00Hz Lamp Flux:2757.01x1 lm		
NAME: LSLH-10%	TYPE:LSLH-10%	WEIGHT:
SPEC.:	DIM.:	SERIAL No.:LSLH-10%
MFR.: LSLH	SUR.:	Shielding Angle:

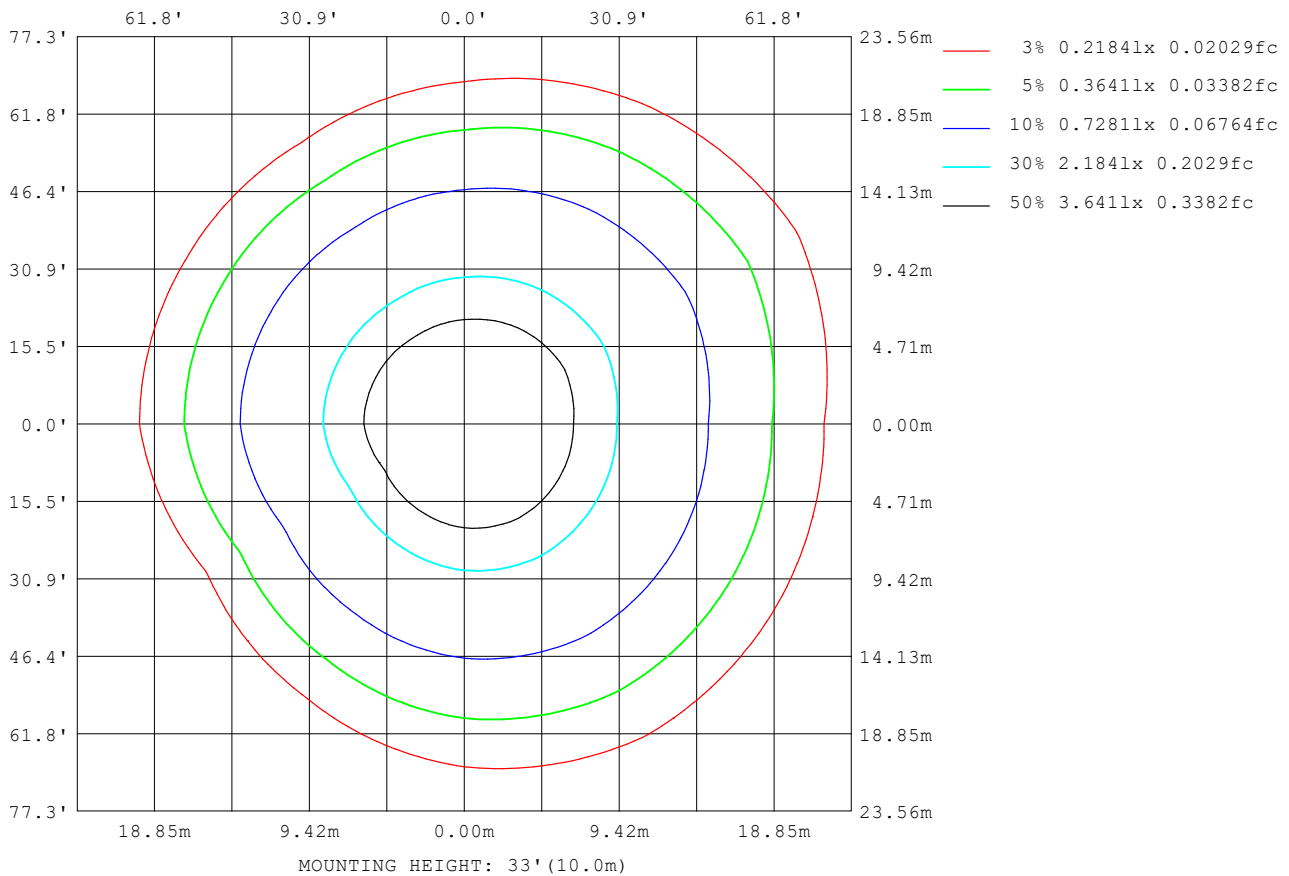

C Range: 0 - 360DEG
 C Interval: 30.0DEG
 Test Speed: HIGH
 Temperature:25.3DEG
 Operators:C
 Test Date:2026-01-29

γ Range: 0 - 180DEG
 γ Interval: 1.0DEG
 Test System:EVERFINE GO-2000B_V1 SYSTEM V2.0.404.7
 Humidity:65.0%
 Test Distance:4.430m [K=1.0000]
 Remarks:

LED Avg.L Report

Test:U:219.47V I:0.1673A P:21.605W PF:0.5883 Freq:50.00Hz Lamp Flux:2757.01x1 lm		
NAME: LSLH-10%	TYPE:LSLH-10%	WEIGHT:
SPEC.:	DIM.:	SERIAL No.:LSLH-10%
MFR.: LSLH	SUR.:	Shielding Angle:

AvgL	cd/m2
L_0~180 (65) av	1741
L_0~180 (75) av	1541
L_0~180 (85) av	1189
L_90~270 (65) av	1734
L_90~270 (75) av	1516
L_90~270 (85) av	1030
L_45 (65) av	1745
L_45 (75) av	1566
L_45 (85) av	1584

Standard: GB/T 29293-2012

C Range: 0 - 360DEG
 C Interval: 30.0DEG
 Test Speed: HIGH
 Temperature:25.3DEG
 Operators:C
 Test Date:2026-01-29

γ Range: 0 - 180DEG
 γ Interval: 1.0DEG
 Test System:EVERFINE GO-2000B_V1 SYSTEM V2.0.404.7
 Humidity:65.0%
 Test Distance:4.430m [K=1.0000]
 Remarks:

Planar Illuminance Curve

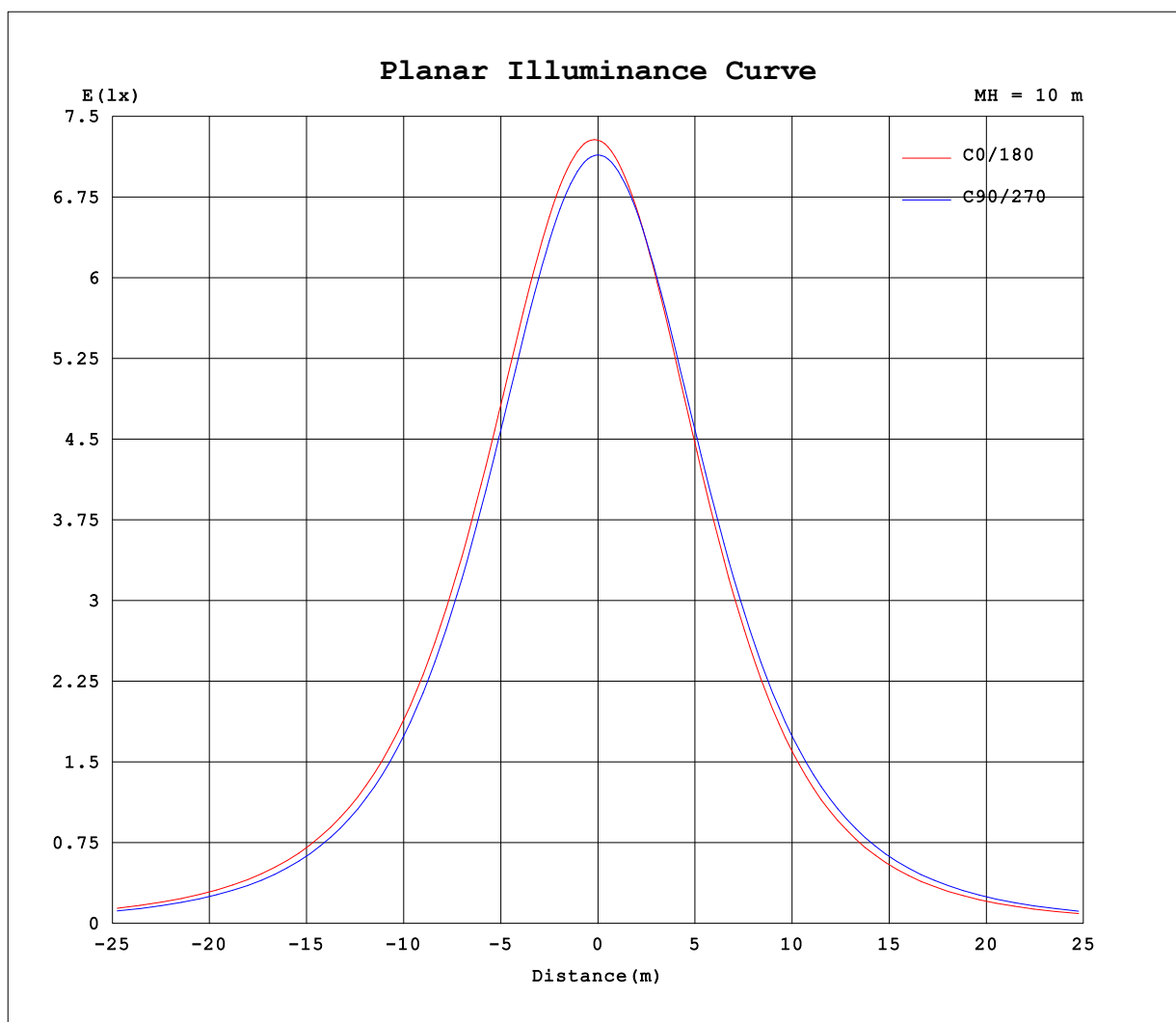

C Range: 0 - 360DEG
 C Interval: 30.0DEG
 Test Speed: HIGH
 Temperature: 25.3DEG
 Operators: C
 Test Date: 2026-01-29

γ Range: 0 - 180DEG
 γ Interval: 1.0DEG
 Test System: EVERFINE GO-2000B_V1 SYSTEM V2.0.404.7
 Humidity: 65.0%
 Test Distance: 4.430m [K=1.0000]
 Remarks:

LUMINOUS DISTRIBUTION INTENSITY DATA

Test:U:219.47V I:0.1673A P:21.605W PF:0.5883 Freq:50.00Hz Lamp Flux:2757.01x1 lm		
NAME: LSLH-10%	TYPE:LSLH-10%	WEIGHT:
SPEC.:	DIM.:	SERIAL No.:LSLH-10%
MFR.: LSLH	SUR.:	Shielding Angle:

Table--1

UNIT: cd

C (DEG) \ γ (DEG)	0	30	60	90	120	150	180	210	240	270	300	330							
0	728	724	718	714	712	712	728	724	718	714	712	712							
5	730	726	720	712	703	698	721	717	712	712	716	721							
10	726	723	717	704	688	679	708	704	700	704	715	724							
15	717	714	709	692	669	653	690	686	682	692	708	722							
20	702	700	695	673	643	622	665	661	659	674	697	714							
25	681	680	676	649	611	584	635	631	630	650	680	701							
30	654	654	650	619	574	541	598	594	595	620	657	682							
35	621	622	618	583	530	493	555	551	553	584	627	657							
40	581	583	580	541	482	440	506	503	506	541	591	625							
45	536	538	536	493	429	384	453	450	454	493	549	587							
50	485	488	486	440	372	325	396	393	398	440	501	543							
55	430	433	432	383	313	265	337	334	338	382	448	493							
60	371	375	374	324	253	205	276	273	277	322	391	439							
65	310	315	313	263	193	147	215	211	215	260	330	381							
70	248	253	251	202	135	90.2	155	151	155	198	268	320							
75	187	192	190	143	79.8	39.2	97.6	93.9	96.0	137	206	258							
80	128	132	131	86.1	29.4	2.20	44.9	40.7	43.1	80.3	145	195							
85	71.8	75.7	75.1	35.3	2.31	2.46	2.19	2.19	2.18	28.8	86.4	135							
90	20.8	25.0	24.5	2.27	2.57	2.79	2.40	2.48	2.47	2.32	34.1	77.8							
95	2.19	2.23	2.29	2.51	2.89	3.17	2.82	2.90	2.85	2.62	2.40	25.9							
100	2.52	2.54	2.58	2.87	3.30	3.57	3.28	3.34	3.27	3.00	2.68	2.46							
105	2.97	2.95	2.96	3.30	3.74	4.02	3.71	3.77	3.67	3.40	3.00	2.75							
110	3.42	3.39	3.39	3.73	4.18	4.46	4.14	4.21	4.08	3.80	3.39	3.13							
115	3.93	3.88	3.87	4.19	4.67	4.97	4.62	4.70	4.56	4.24	3.84	3.60							
120	4.46	4.40	4.37	4.67	5.13	5.52	5.07	5.15	4.99	4.64	4.26	4.02							
125	4.96	4.87	4.85	5.06	5.54	6.02	5.47	5.58	5.34	4.99	4.67	4.43							
130	5.34	5.25	5.21	5.40	5.85	6.32	5.87	5.99	5.68	5.33	5.04	4.81							
135	5.69	5.62	5.54	5.71	6.13	6.53	6.18	6.24	5.92	5.59	5.32	5.11							
140	6.01	5.95	5.84	5.98	6.36	6.61	6.36	6.42	6.14	5.85	5.60	5.42							
145	6.25	6.25	6.15	6.25	6.59	6.76	6.60	6.50	6.37	6.10	5.89	5.76							
150	6.54	6.57	6.50	6.54	6.84	6.73	6.88	6.37	6.61	6.39	6.20	6.08							
155	6.85	6.93	6.85	6.84	7.07	7.03	7.18	6.68	6.89	6.71	6.55	6.43							
160	7.19	7.32	7.15	7.04	7.27	7.48	7.54	7.17	7.15	6.98	6.91	6.81							
165	7.55	7.67	7.38	7.23	7.46	7.76	7.93	7.62	7.39	7.20	7.21	7.23							
170	7.74	7.83	7.46	7.31	7.53	7.85	8.22	7.90	7.54	7.35	7.37	7.52							
175	7.62	7.53	7.14	7.01	7.15	7.48	7.93	7.75	7.31	7.15	7.17	7.43							
180	7.41	7.28	6.88	6.75	6.79	7.08	7.43	7.28	6.88	6.73	6.79	7.09							

C Range: 0 - 360DEG
C Interval: 30.0DEG
Test Speed: HIGH
Temperature:25.3DEG
Operators:C
Test Date:2026-01-29

γ Range: 0 - 180DEG
γ Interval: 1.0DEG
Test System:EVERFINE GO-2000B_V1 SYSTEM V2.0.404.7
Humidity:65.0%
Test Distance:4.430m [K=1.0000]
Remarks:

LUMINOUS DISTRIBUTION INTENSITY DATA

Test:U:219.47V I:0.1673A P:21.605W PF:0.5883 Freq:50.00Hz Lamp Flux:2757.01x1 lm		
NAME: LSLH-10%	TYPE:LSLH-10%	WEIGHT:
SPEC.:	DIM.:	SERIAL No.:LSLH-10%
MFR.: LSLH	SUR.:	Shielding Angle:

Table--1

UNIT: cd

C (DEG) \ γ (DEG)	0	30	60	90	120	150	180	210	240	270	300	330							
0	728	724	718	714	712	712	728	724	718	714	712	712							
5	730	726	720	712	703	698	721	717	712	712	716	721							
10	726	723	717	704	688	679	708	704	700	704	715	724							
15	717	714	709	692	669	653	690	686	682	692	708	722							
20	702	700	695	673	643	622	665	661	659	674	697	714							
25	681	680	676	649	611	584	635	631	630	650	680	701							
30	654	654	650	619	574	541	598	594	595	620	657	682							
35	621	622	618	583	530	493	555	551	553	584	627	657							
40	581	583	580	541	482	440	506	503	506	541	591	625							
45	536	538	536	493	429	384	453	450	454	493	549	587							
50	485	488	486	440	372	325	396	393	398	440	501	543							
55	430	433	432	383	313	265	337	334	338	382	448	493							
60	371	375	374	324	253	205	276	273	277	322	391	439							
65	310	315	313	263	193	147	215	211	215	260	330	381							
70	248	253	251	202	135	90.2	155	151	155	198	268	320							
75	187	192	190	143	79.8	39.2	97.6	93.9	96.0	137	206	258							
80	128	132	131	86.1	29.4	2.20	44.9	40.7	43.1	80.3	145	195							
85	71.8	75.7	75.1	35.3	2.31	2.46	2.19	2.19	2.18	28.8	86.4	135							
90	20.8	25.0	24.5	2.27	2.57	2.79	2.40	2.48	2.47	2.32	34.1	77.8							
95	2.19	2.23	2.29	2.51	2.89	3.17	2.82	2.90	2.85	2.62	2.40	25.9							
100	2.52	2.54	2.58	2.87	3.30	3.57	3.28	3.34	3.27	3.00	2.68	2.46							
105	2.97	2.95	2.96	3.30	3.74	4.02	3.71	3.77	3.67	3.40	3.00	2.75							
110	3.42	3.39	3.39	3.73	4.18	4.46	4.14	4.21	4.08	3.80	3.39	3.13							
115	3.93	3.88	3.87	4.19	4.67	4.97	4.62	4.70	4.56	4.24	3.84	3.60							
120	4.46	4.40	4.37	4.67	5.13	5.52	5.07	5.15	4.99	4.64	4.26	4.02							
125	4.96	4.87	4.85	5.06	5.54	6.02	5.47	5.58	5.34	4.99	4.67	4.43							
130	5.34	5.25	5.21	5.40	5.85	6.32	5.87	5.99	5.68	5.33	5.04	4.81							
135	5.69	5.62	5.54	5.71	6.13	6.53	6.18	6.24	5.92	5.59	5.32	5.11							
140	6.01	5.95	5.84	5.98	6.36	6.61	6.36	6.42	6.14	5.85	5.60	5.42							
145	6.25	6.25	6.15	6.25	6.59	6.76	6.60	6.50	6.37	6.10	5.89	5.76							
150	6.54	6.57	6.50	6.54	6.84	6.73	6.88	6.37	6.61	6.39	6.20	6.08							
155	6.85	6.93	6.85	6.84	7.07	7.03	7.18	6.68	6.89	6.71	6.55	6.43							
160	7.19	7.32	7.15	7.04	7.27	7.48	7.54	7.17	7.15	6.98	6.91	6.81							
165	7.55	7.67	7.38	7.23	7.46	7.76	7.93	7.62	7.39	7.20	7.21	7.23							
170	7.74	7.83	7.46	7.31	7.53	7.85	8.22	7.90	7.54	7.35	7.37	7.52							
175	7.62	7.53	7.14	7.01	7.15	7.48	7.93	7.75	7.31	7.15	7.17	7.43							
180	7.41	7.28	6.88	6.75	6.79	7.08	7.43	7.28	6.88	6.73	6.79	7.09							

C Range: 0 - 360DEG
C Interval: 30.0DEG
Test Speed: HIGH
Temperature:25.3DEG
Operators:C
Test Date:2026-01-29

γ Range: 0 - 180DEG
γ Interval: 1.0DEG
Test System:EVERFINE GO-2000B_V1 SYSTEM V2.0.404.7
Humidity:65.0%
Test Distance:4.430m [K=1.0000]
Remarks:

LUMINAIRE PHOTOMETRIC TEST REPORT

Test:U:219.37V I:0.8197A P:176.03W PF:0.9789 Freq:50.00Hz Lamp Flux:22915.59x1 lm		
NAME: LSLH-175W	TYPE:	WEIGHT:
SPEC.:	DIM.:	SERIAL No.:LSLH-170W
MFR.: LSLH	SUR.:	Shielding Angle:

DATA OF LAMP		PHOTOMETRIC DATA Eff: 130.18 lm/W			
MODEL	LSLH-175W	Imax (cd)	6934	S/MH (C0/180)	1.20
NOMINAL POWER (W)	175	LOR (%)	100.0	S/MH (C90/270)	1.30
RATED VOLTAGE (V)	220	TOTAL FLUX (lm)	22916	η UP, DN (C0-180)	0.7, 49.9
NOMINAL FLUX (lm)	22915.6	CIE CLASS	DIRECT	η UP, DN (C180-360)	0.7, 48.6
LAMPS INSIDE	1	η up (%)	1.5	CIBSE SHR NOM	1.25
TEST VOLTAGE (V)	220	η down (%)	98.5	CIBSE SHR MAX	1.35

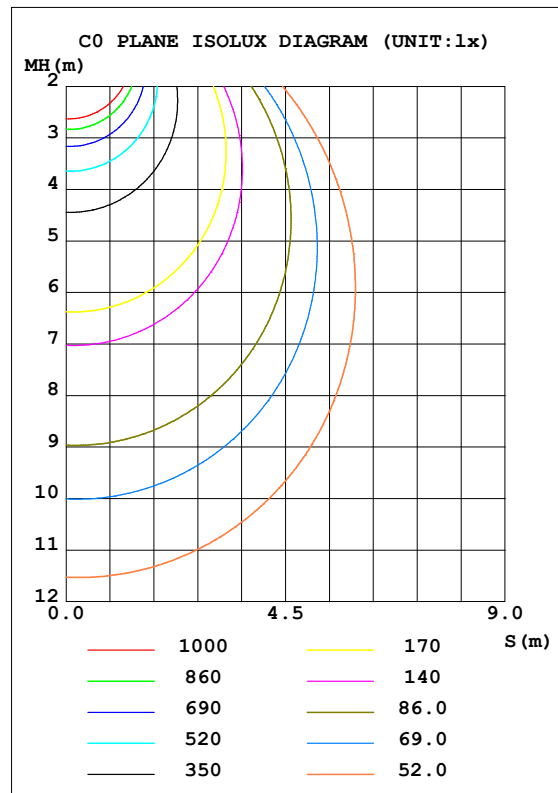
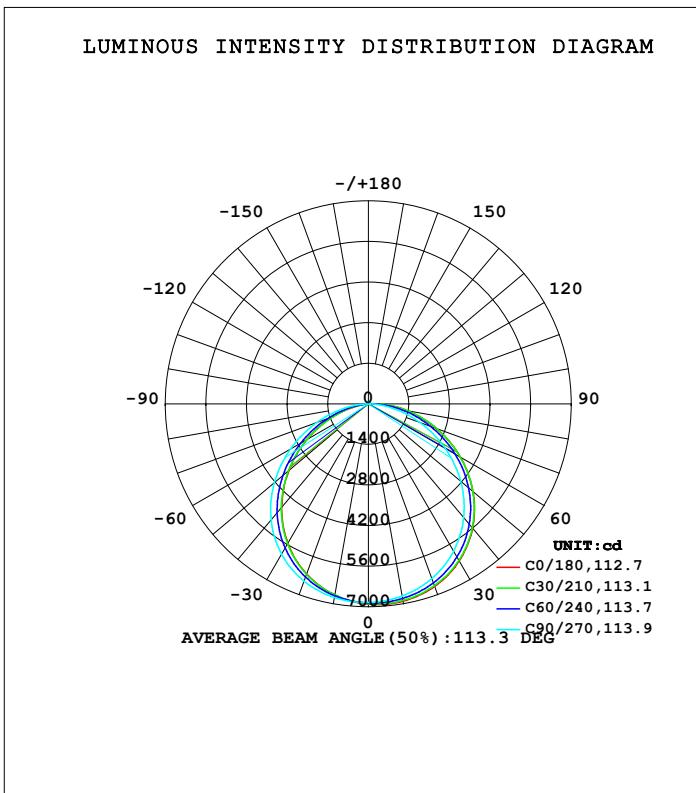

C Range: 0 - 360DEG
C Interval: 30.0DEG
Test Speed: HIGH
Temperature: 25.3DEG
Operators: H
Test Date: 2025-07-24

γ Range: 0 - 180DEG
γ Interval: 1.0DEG
Test System: EVERFINE GO-2000B_V1 SYSTEM V2.0.404.7
Humidity: 65.0%
Test Distance: 4.430m [K=1.0000]
Remarks:

ZONAL FLUX DIAGRAM

ZONAL FLUX DIAGRAM:

γ	C0	C45	C90	C135	C180	C225	C270	C315	γ	Φ zone	Φ total	%lum, lamp
10	6908	6848	6729	6615	6690	6703	6781	6874	0- 10	650.7	650.7	3.2,3.2
20	6697	6617	6409	6169	6243	6304	6501	6694	10- 20	1874	2524	12.4,12.4
30	6264	6171	5874	5497	5557	5662	5987	6288	20- 30	2862	5386	26.5,26.5
40	5595	5497	5116	4612	4651	4786	5221	5638	30- 40	3471	8858	43.6,43.6
50	4708	4610	4159	3565	3581	3725	4233	4753	40- 50	3603	12460	61.3,61.3
60	3651	3553	3058	2429	2432	2561	3091	3683	50- 60	3237	15698	77.3,77.3
70	2500	2404	1902	1303	1298	1398	1894	2509	60- 70	2453	18150	89.3,89.3
80	1351	1264	807.5	300.2	285.1	355.4	769.6	1342	70- 80	1420	19570	96.3,96.3
90	321.8	258.1	20.32	22.85	22.54	23.26	21.03	302.0	80- 90	451.2	20021	98.5,98.5
100	21.85	23.01	25.78	29.68	30.00	29.97	26.16	23.19	90-100	47.73	20069	98.8,98.8
110	30.57	31.25	34.16	38.29	38.52	38.22	34.01	30.85	100-110	31.76	20101	98.9,98.9
120	41.29	41.54	43.91	48.64	48.25	47.93	42.91	40.30	110-120	39.34	20140	99.1,99.1
130	49.35	49.31	50.51	55.94	55.06	53.95	48.21	46.56	120-130	43.02	20183	99.3,99.3
140	55.06	55.19	55.53	59.64	59.56	57.91	53.04	52.12	130-140	41.54	20225	99.5,99.5
150	60.54	61.27	60.81	62.44	64.48	61.09	58.20	57.99	140-150	36.64	20261	99.7,99.7
160	65.95	68.02	65.86	68.32	70.34	66.58	63.97	64.66	150-160	29.35	20291	99.9,99.9
170	71.53	72.40	68.59	71.40	76.39	72.05	68.04	70.18	160-170	19.62	20310	100,100
180	67.87	65.16	62.12	63.96	67.90	65.17	62.11	63.96	170-180	6.697	20317	100,100
DEG	LUMINOUS INTENSITY:cd									UNIT:lm		

C Range: 0 - 360DEG
 C Interval: 30.0DEG
 Test Speed: HIGH
 Temperature:25.3DEG
 Operators:H
 Test Date:2025-07-24

γ Range: 0 - 180DEG
 γ Interval: 1.0DEG
 Test System:EVERFINE GO-2000B_V1 SYSTEM V2.0.404.7
 Humidity:65.0%
 Test Distance:4.430m [K=1.0000]
 Remarks:

LUMINANCE LIMITATION CURVES

Test:U:219.37V I:0.8197A P:176.03W PF:0.9789 Freq:50.00Hz Lamp Flux:22915.59x1 lm		
NAME: LSLH-175W	TYPE:	WEIGHT:
SPEC.:	DIM.:	SERIAL No.:LSLH-170W
MFR.: LSLH	SUR.:	Shielding Angle:

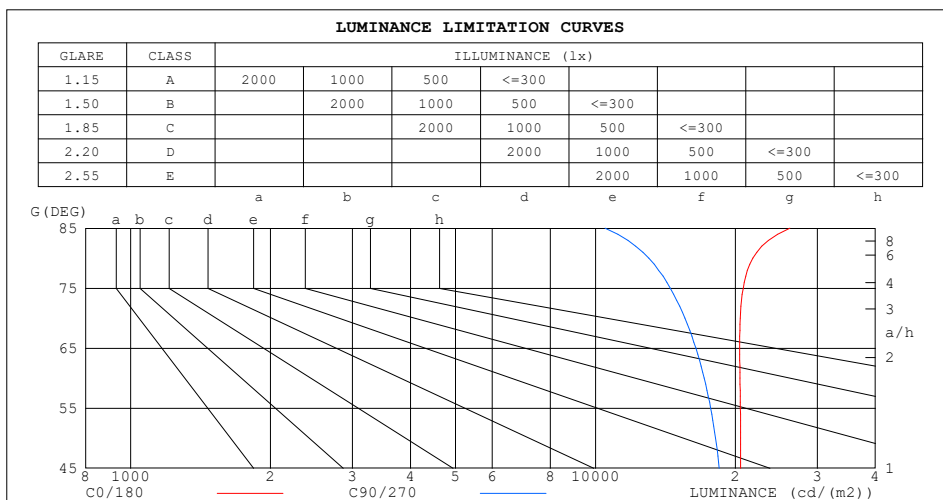

LUMINANCE cd/(m2)		
G (DEG)	C0/180	C90/270
85	26173	10489
80	21801	13029
75	20790	14487
70	20481	15579
65	20422	16441
60	20461	17137
55	20504	17690
50	20521	18128
45	20516	18466

C Range: 0 - 360DEG
C Interval: 30.0DEG
Test Speed: HIGH
Temperature:25.3DEG
Operators:H
Test Date:2025-07-24

γ Range: 0 - 180DEG
γ Interval: 1.0DEG
Test System:EVERFINE GO-2000B_V1 SYSTEM V2.0.404.7
Humidity:65.0%
Test Distance:4.430m [K=1.0000]
Remarks:

CU AND LUMINAIRE BUDGETARY ESTIMATE DIAGRAM

Test:U:219.37V I:0.8197A P:176.03W PF:0.9789 Freq:50.00Hz Lamp Flux:22915.59x1 lm		
NAME: LSLH-175W	TYPE:	WEIGHT:
SPEC.:	DIM.:	SERIAL No.:LSLH-170W
MFR.: LSLH	SUR.:	Shielding Angle:

ρ_{cc}	80%			70%			50%			30%			10%			0
ρ_w	50%	30%	10%	50%	30%	10%	50%	30%	10%	50%	30%	10%	50%	30%	10%	0
ρ_{fc}	20%			20%			20%			20%			20%			0
RCR	RCR:Room Cavity Ratio						Coefficients of Utilization(CU)									
0.0	1.19	1.19	1.19	1.16	1.16	1.16	1.10	1.10	1.10	1.05	1.05	1.05	1.01	1.01	1.01	.99
1.0	1.03	.99	.95	1.01	.97	.93	.96	.93	.90	.92	.90	.87	.88	.86	.84	.82
2.0	.90	.83	.77	.88	.82	.76	.84	.79	.74	.81	.76	.72	.77	.74	.70	.68
3.0	.79	.71	.64	.77	.70	.63	.74	.67	.62	.71	.65	.61	.68	.64	.60	.57
4.0	.70	.61	.54	.68	.60	.54	.66	.58	.53	.63	.57	.52	.61	.55	.51	.49
5.0	.62	.53	.47	.61	.53	.46	.59	.51	.46	.57	.50	.45	.55	.49	.44	.42
6.0	.56	.47	.41	.55	.47	.40	.53	.45	.40	.51	.44	.39	.49	.44	.39	.37
7.0	.51	.42	.36	.50	.42	.36	.48	.41	.35	.47	.40	.35	.45	.39	.34	.32
8.0	.46	.38	.32	.46	.37	.32	.44	.37	.31	.43	.36	.31	.41	.35	.31	.29
9.0	.42	.34	.29	.42	.34	.29	.41	.33	.28	.39	.33	.28	.38	.32	.28	.26
10.0	.39	.31	.26	.39	.31	.26	.37	.30	.26	.36	.30	.25	.35	.30	.25	.24

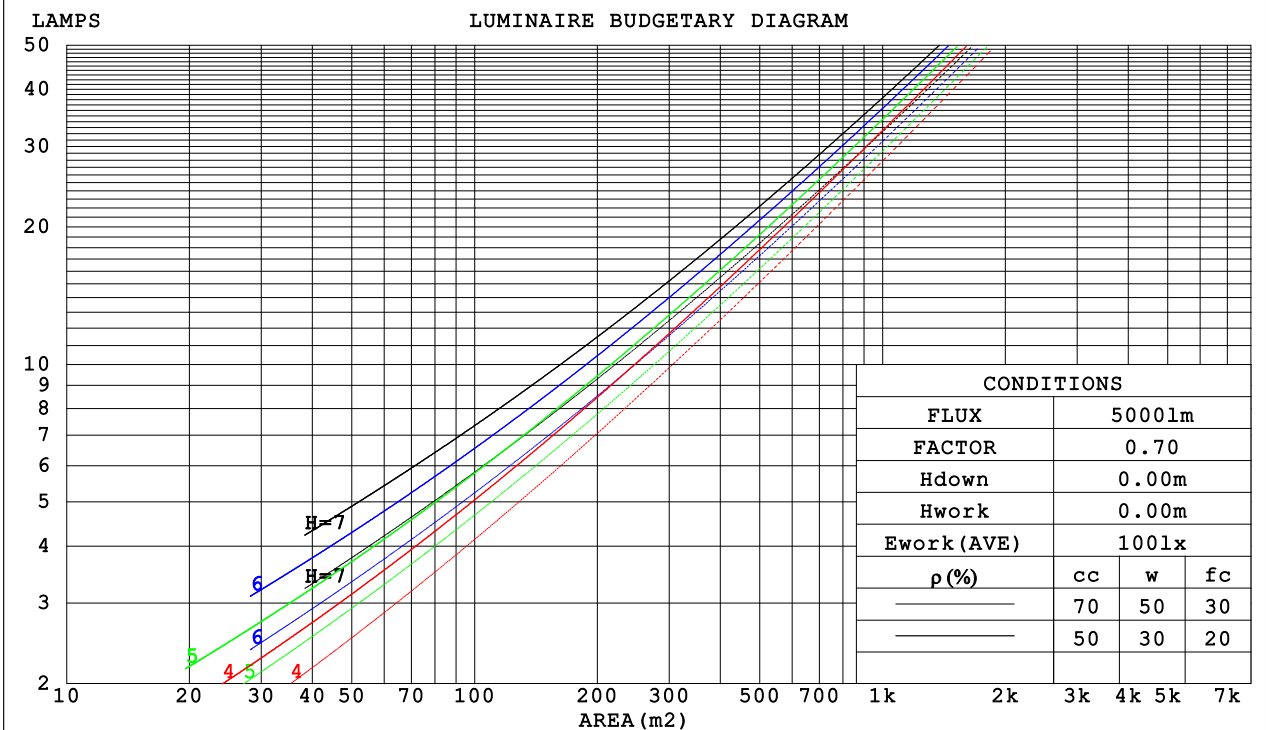

C Range: 0 - 360DEG
C Interval: 30.0DEG
Test Speed: HIGH
Temperature:25.3DEG
Operators:H
Test Date:2025-07-24

γ Range: 0 - 180DEG
 γ Interval: 1.0DEG
Test System:EVERFINE GO-2000B_V1 SYSTEM V2.0.404.7
Humidity:65.0%
Test Distance:4.430m [K=1.0000]
Remarks:

WEC AND CCEC

Test:U:219.37V I:0.8197A P:176.03W PF:0.9789 Freq:50.00Hz Lamp Flux:22915.59x1 lm		
NAME: LSLH-175W	TYPE:	WEIGHT:
SPEC.:	DIM.:	SERIAL No.:LSLH-170W
MFR.: LSLH	SUR.:	Shielding Angle:

ρcc	80%			70%			50%			30%			10%			0
ρw	50%	30%	10%	50%	30%	10%	50%	30%	10%	50%	30%	10%	50%	30%	10%	0
ρfc	20%			20%			20%			20%			20%			0
RCR	RCR:Room Cavity Ratio						Wall Exitance Coefficients (WEC)									
0.0																
1.0	.313	.178	.056	.306	.174	.055	.292	.167	.053	.279	.161	.052	.267	.155	.050	
2.0	.293	.161	.049	.287	.158	.049	.274	.152	.047	.263	.147	.046	.252	.143	.045	
3.0	.271	.144	.043	.265	.142	.043	.254	.138	.042	.244	.134	.041	.234	.130	.040	
4.0	.250	.130	.038	.244	.128	.038	.235	.124	.037	.225	.121	.037	.217	.118	.036	
5.0	.231	.118	.034	.226	.116	.034	.217	.113	.033	.209	.110	.033	.201	.108	.032	
6.0	.214	.107	.031	.210	.106	.030	.202	.103	.030	.195	.101	.030	.188	.099	.029	
7.0	.199	.098	.028	.195	.097	.028	.188	.095	.027	.182	.093	.027	.175	.091	.027	
8.0	.186	.091	.026	.182	.090	.025	.176	.088	.025	.170	.086	.025	.165	.085	.025	
9.0	.174	.084	.024	.171	.083	.023	.165	.082	.023	.160	.080	.023	.155	.079	.023	
10.0	.164	.078	.022	.161	.078	.022	.156	.076	.021	.151	.075	.021	.146	.074	.021	

ρcc	80%			70%			50%			30%			10%			0
ρw	50%	30%	10%	50%	30%	10%	50%	30%	10%	50%	30%	10%	50%	30%	10%	0
ρfc	20%			20%			20%			20%			20%			0
RCR	RCR:Room Cavity Ratio						Ceiling Cavity Exitance Coefficients (CCEC)									
0.0	.202	.202	.202	.172	.172	.172	.118	.118	.118	.068	.068	.068	.022	.022	.022	
1.0	.192	.167	.145	.164	.144	.125	.112	.099	.086	.065	.057	.050	.021	.018	.016	
2.0	.184	.143	.109	.157	.123	.094	.108	.085	.066	.062	.050	.039	.020	.016	.013	
3.0	.176	.126	.085	.151	.108	.074	.104	.075	.052	.060	.044	.031	.019	.014	.010	
4.0	.168	.112	.070	.144	.097	.060	.099	.068	.043	.057	.040	.025	.018	.013	.008	
5.0	.161	.102	.059	.138	.088	.051	.095	.062	.036	.055	.036	.021	.018	.012	.007	
6.0	.154	.094	.051	.132	.081	.044	.091	.057	.031	.053	.033	.019	.017	.011	.006	
7.0	.147	.087	.045	.126	.075	.039	.087	.053	.028	.051	.031	.016	.016	.010	.005	
8.0	.140	.081	.040	.121	.070	.035	.084	.049	.025	.049	.029	.015	.016	.010	.005	
9.0	.134	.076	.037	.116	.066	.032	.080	.046	.023	.047	.027	.014	.015	.009	.004	
10.0	.129	.072	.034	.111	.062	.030	.077	.044	.021	.045	.026	.013	.015	.009	.004	

C Range: 0 - 360DEG
 C Interval: 30.0DEG
 Test Speed: HIGH
 Temperature:25.3DEG
 Operators:H
 Test Date:2025-07-24

γ Range: 0 - 180DEG
 γ Interval: 1.0DEG
 Test System:EVERFINE GO-2000B_V1 SYSTEM V2.0.404.7
 Humidity:65.0%
 Test Distance:4.430m [K=1.0000]
 Remarks:

UGR(Unified Glare Rating) Table

Test:U:219.37V I:0.8197A P:176.03W PF:0.9789 Freq:50.00Hz Lamp Flux:22915.59x1 lm										
NAME: LSLH-175W					TYPE:			WEIGHT:		
SPEC.:					DIM.:			SERIAL No.:LSLH-170W		
MFR.: LSLH					SUR.:			Shielding Angle:		
ceiling/cavity	0.7	0.7	0.5	0.5	0.3	0.7	0.7	0.5	0.5	0.3
walls	0.5	0.3	0.5	0.3	0.3	0.5	0.3	0.5	0.3	0.3
working plane	0.2	0.2	0.2	0.2	0.2	0.2	0.2	0.2	0.2	0.2
Room dimensions	Viewed crosswise					Viewed endwise				
x = 2H y = 2H	23.8	25.3	24.1	25.6	25.8	23.2	24.7	23.5	24.9	25.2
3H	25.6	27.0	25.9	27.3	27.5	24.7	26.1	25.0	26.4	26.6
4H	26.4	27.8	26.8	28.0	28.3	25.3	26.6	25.7	26.9	27.2
6H	27.2	28.4	27.5	28.7	29.0	25.8	27.0	26.1	27.3	27.6
8H	27.5	28.7	27.8	29.0	29.3	25.9	27.1	26.3	27.4	27.7
12H	27.7	28.9	28.1	29.2	29.6	26.0	27.1	26.3	27.4	27.8
4H 2H	24.5	25.8	24.8	26.1	26.4	24.0	25.3	24.3	25.6	25.9
3H	26.5	27.6	26.9	28.0	28.3	25.7	26.9	26.1	27.2	27.6
4H	27.5	28.5	27.9	28.9	29.2	26.5	27.6	26.9	27.9	28.3
6H	28.3	29.3	28.8	29.7	30.0	27.1	28.0	27.5	28.4	28.8
8H	28.7	29.6	29.2	30.0	30.4	27.3	28.2	27.7	28.6	29.0
12H	29.1	29.9	29.5	30.3	30.7	27.4	28.2	27.9	28.6	29.1
8H 4H	27.8	28.7	28.2	29.1	29.5	27.0	27.8	27.4	28.2	28.7
6H	28.9	29.6	29.3	30.0	30.5	27.8	28.5	28.2	28.9	29.4
8H	29.4	30.1	29.9	30.5	31.0	28.1	28.7	28.6	29.2	29.7
12H	29.9	30.5	30.4	31.0	31.5	28.3	28.9	28.8	29.4	29.9
12H 4H	27.8	28.6	28.3	29.0	29.5	27.0	27.8	27.5	28.3	28.7
6H	29.0	29.6	29.5	30.1	30.6	27.9	28.6	28.4	29.0	29.5
8H	29.6	30.1	30.1	30.6	31.1	28.3	28.9	28.8	29.4	29.9
Variations with the observer position at spacings:										
S = 1.0H	+ 0.1 / - 0.2					+ 0.1 / - 0.2				
1.5H	+ 0.2 / - 0.3					+ 0.2 / - 0.4				
2.0H	+ 0.1 / - 0.3					+ 0.2 / - 0.5				

CIE Pub.117, 20317 lm Total Lamp Luminous Flux Corrected (8log(F/F0) = 10.5)

C Range: 0 - 360DEG	γ Range: 0 - 180DEG
C Interval: 30.0DEG	γ Interval: 1.0DEG
Test Speed: HIGH	Test System:EVERFINE GO-2000B_V1 SYSTEM V2.0.404.7
Temperature:25.3DEG	Humidity:65.0%
Operators:H	Test Distance:4.430m [K=1.0000]
Test Date:2025-07-24	Remarks:

UTILIZATION FACTORS TABLE

Test:U:219.37V I:0.8197A P:176.03W PF:0.9789 Freq:50.00Hz Lamp Flux:22915.59x1 lm		
NAME: LSLH-175W	TYPE:	WEIGHT:
SPEC.:	DIM.:	SERIAL No.: LSLH-170W
MFR.: LSLH	SUR.:	Shielding Angle:

REFLECTANCE										
Ceiling	0.8	0.8	0.8	0.7	0.7	0.7	0.5	0.5	0.5	0
Walls	0.7	0.5	0.3	0.7	0.5	0.3	0.7	0.5	0.3	0
Working plane	0.2	0.2	0.2	0.2	0.2	0.2	0.2	0.2	0.2	0
ROOM INDEX	UTILIZATION FACTORS (PERCENT) $k(RI) \times RCR = 5$									
k = 0.60	57	45	38	56	45	38	55	44	38	31
0.80	67	55	48	66	55	48	64	54	47	40
1.00	75	64	57	74	63	56	72	65	56	49
1.25	82	72	65	81	71	64	78	69	63	56
1.50	87	77	70	86	76	70	82	75	69	61
2.00	94	86	79	92	84	78	89	82	77	68
2.50	98	90	84	96	89	83	92	86	81	73
3.00	102	95	89	99	93	88	95	90	85	77
4.00	106	100	95	103	98	94	99	94	91	81
5.00	108	103	99	105	101	97	101	97	94	84
ROOM INDEX	UF(total)									Direct
According to DIN EN 13032-2 2004			Suspended				SHRNOM = 1.25			

C Range: 0 - 360DEG
C Interval: 30.0DEG
Test Speed: HIGH
Temperature: 25.3DEG
Operators: H
Test Date: 2025-07-24

γ Range: 0 - 180DEG
 γ Interval: 1.0DEG
Test System: EVERFINE GO-2000B_V1 SYSTEM V2.0.404.7
Humidity: 65.0%
Test Distance: 4.430m [K=1.0000]
Remarks:

ISOCANDELA DIAGRAM

Test:U:219.37V I:0.8197A P:176.03W PF:0.9789 Freq:50.00Hz Lamp Flux:22915.59x1 lm		
NAME: LSLH-175W	TYPE:	WEIGHT:
SPEC.:	DIM.:	SERIAL No.:LSLH-170W
MFR.: LSLH	SUR.:	Shielding Angle:

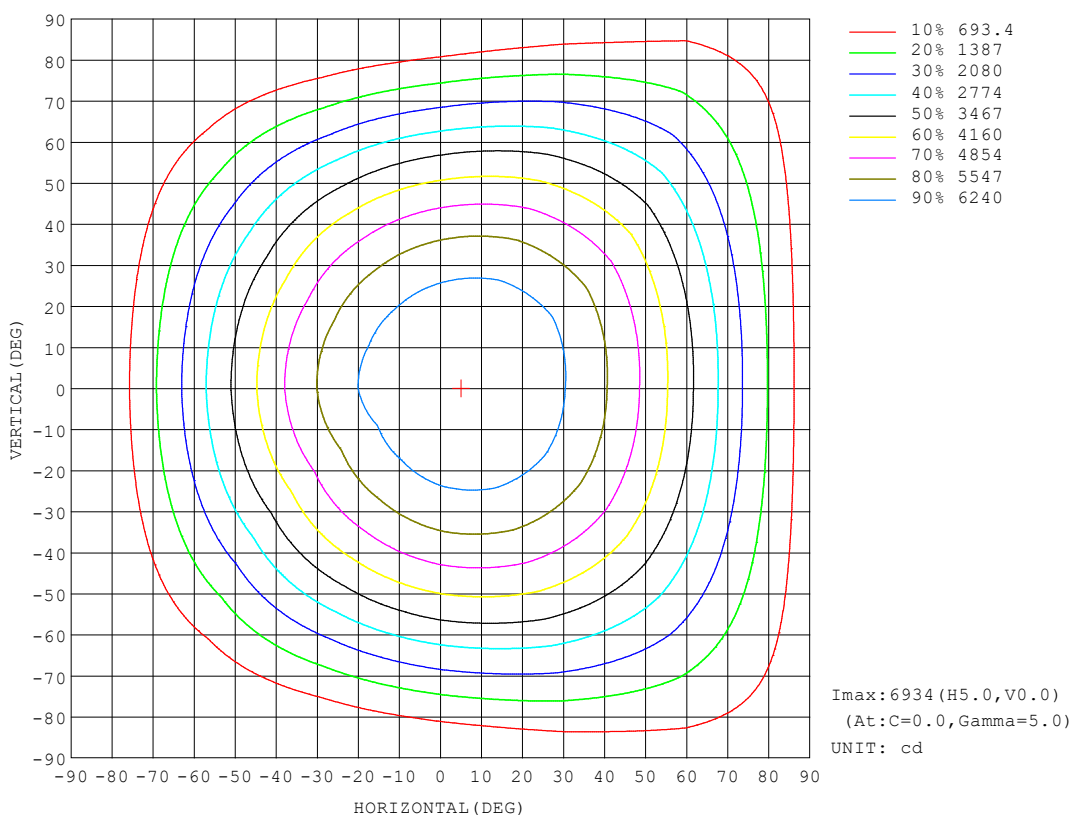

C Range: 0 - 360DEG
C Interval: 30.0DEG
Test Speed: HIGH
Temperature:25.3DEG
Operators:H
Test Date:2025-07-24

γ Range: 0 - 180DEG
γ Interval: 1.0DEG
Test System:EVERFINE GO-2000B_V1 SYSTEM V2.0.404.7
Humidity:65.0%
Test Distance:4.430m [K=1.0000]
Remarks:

AAI Figure

Test:U:219.37V I:0.8197A P:176.03W PF:0.9789 Freq:50.00Hz Lamp Flux:22915.59x1 lm		
NAME: LSLH-175W	TYPE:	WEIGHT:
SPEC.:	DIM.:	SERIAL No.:LSLH-170W
MFR.: LSLH	SUR.:	Shielding Angle:

Flux out:14792 lm

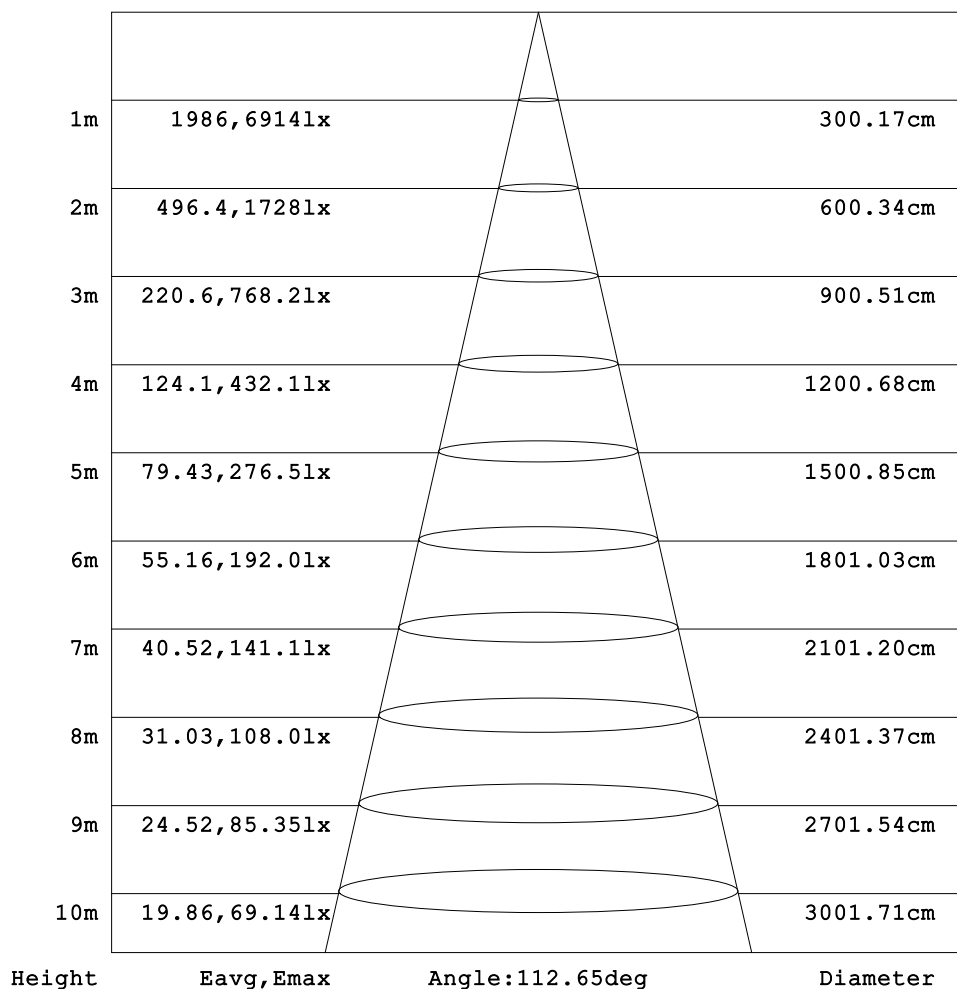

Note:The Curves indicate the illuminated area and the average illumination when the luminaire is at different distance.

C Range: 0 - 360DEG
C Interval: 30.0DEG
Test Speed: HIGH
Temperature:25.3DEG
Operators:H
Test Date:2025-07-24

γ Range: 0 - 180DEG
γ Interval: 1.0DEG
Test System:EVERFINE GO-2000B_V1 SYSTEM V2.0.404.7
Humidity:65.0%
Test Distance:4.430m [K=1.0000]
Remarks:

ISOLUX DIAGRAM

Test:U:219.37V I:0.8197A P:176.03W PF:0.9789 Freq:50.00Hz Lamp Flux:22915.59x1 lm		
NAME: LSLH-175W	TYPE:	WEIGHT:
SPEC.:	DIM.:	SERIAL No.:LSLH-170W
MFR.: LSLH	SUR.:	Shielding Angle:

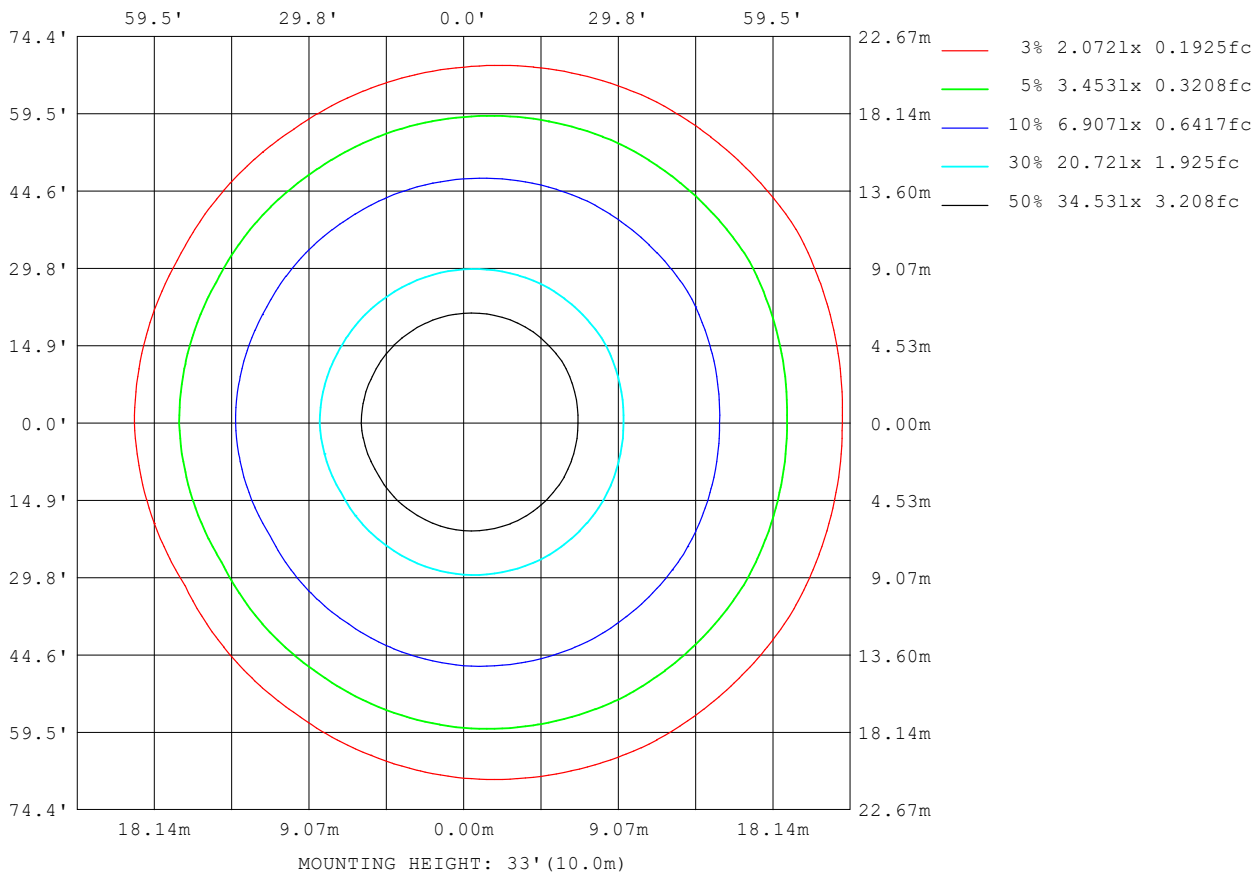

C Range: 0 - 360DEG
 C Interval: 30.0DEG
 Test Speed: HIGH
 Temperature:25.3DEG
 Operators:H
 Test Date:2025-07-24

γ Range: 0 - 180DEG
 γ Interval: 1.0DEG
 Test System:EVERFINE GO-2000B_V1 SYSTEM V2.0.404.7
 Humidity:65.0%
 Test Distance:4.430m [K=1.0000]
 Remarks:

LED Avg.L Report

Test:U:219.37V I:0.8197A P:176.03W PF:0.9789 Freq:50.00Hz Lamp Flux:22915.59x1 lm		
NAME: LSLH-175W	TYPE:	WEIGHT:
SPEC.:	DIM.:	SERIAL No.:LSLH-170W
MFR.: LSLH	SUR.:	Shielding Angle:

AvgL	cd/m2
L_0~180 (65) av	16363
L_0~180 (75) av	14563
L_0~180 (85) av	13405
L_90~270 (65) av	16479
L_90~270 (75) av	14360
L_90~270 (85) av	9698
L_45 (65) av	16437
L_45 (75) av	14563
L_45 (85) av	12922

Standard: GB/T 29293-2012

C Range: 0 - 360DEG
 C Interval: 30.0DEG
 Test Speed: HIGH
 Temperature:25.3DEG
 Operators:H
 Test Date:2025-07-24

γ Range: 0 - 180DEG
 γ Interval: 1.0DEG
 Test System:EVERFINE GO-2000B_V1 SYSTEM V2.0.404.7
 Humidity:65.0%
 Test Distance:4.430m [K=1.0000]
 Remarks:

Planar Illuminance Curve

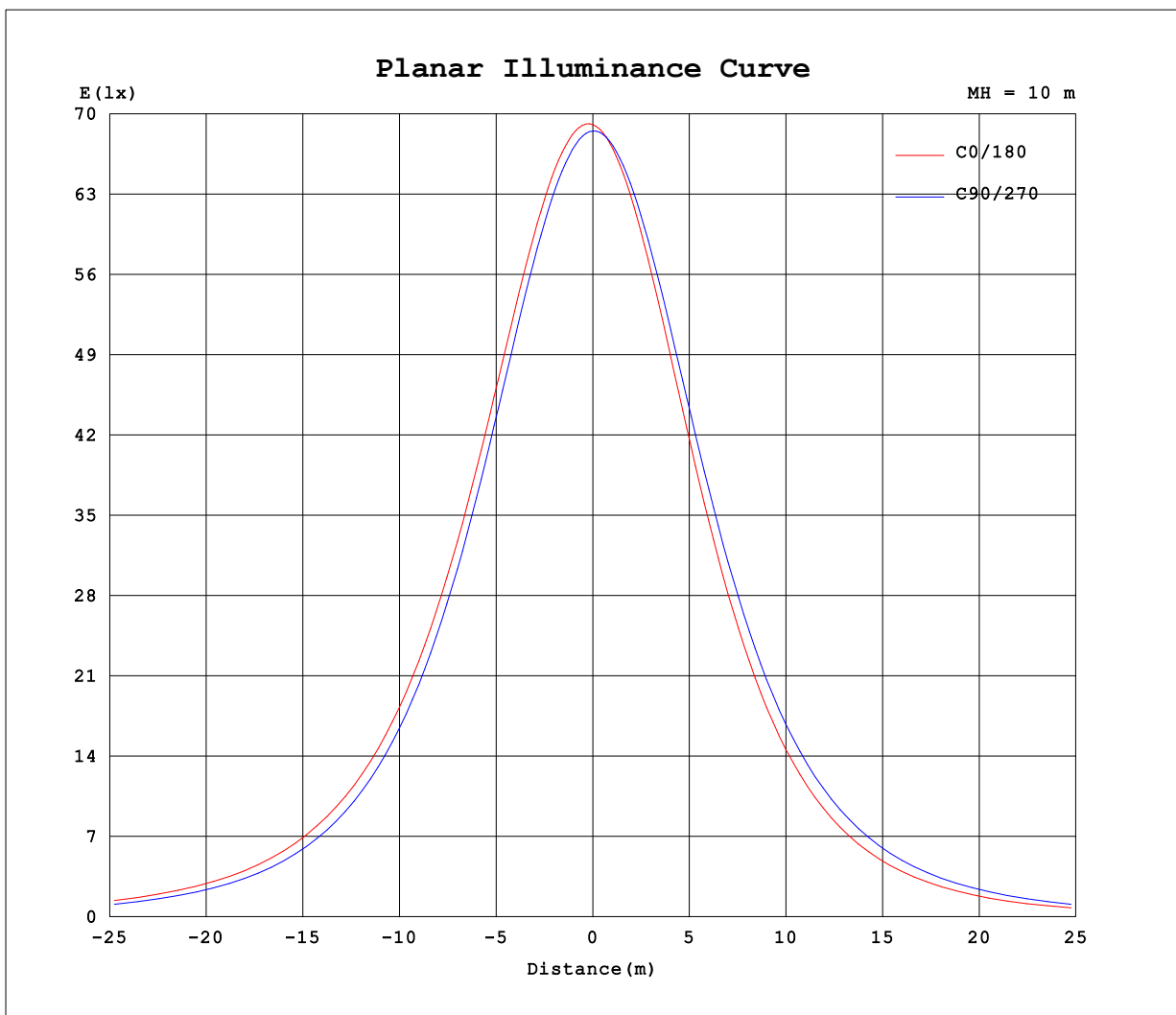

C Range: 0 - 360DEG
 C Interval: 30.0DEG
 Test Speed: HIGH
 Temperature: 25.3DEG
 Operators: H
 Test Date: 2025-07-24

γ Range: 0 - 180DEG
 γ Interval: 1.0DEG
 Test System: EVERFINE GO-2000B_V1 SYSTEM V2.0.404.7
 Humidity: 65.0%
 Test Distance: 4.430m [K=1.0000]
 Remarks:

LUMINOUS DISTRIBUTION INTENSITY DATA

Test:U:219.37V I:0.8197A P:176.03W PF:0.9789 Freq:50.00Hz Lamp Flux:22915.59x1 lm		
NAME: LSLH-175W	TYPE:	WEIGHT:
SPEC.:	DIM.:	SERIAL No.:LSLH-170W
MFR.: LSLH	SUR.:	Shielding Angle:

Table--1

UNIT: cd

C (DEG) \ γ (DEG)	0	30	60	90	120	150	180	210	240	270	300	330						
0	6907	6890	6867	6852	6845	6849	6907	6890	6867	6852	6845	6849						
5	6934	6911	6865	6814	6767	6748	6826	6816	6820	6841	6873	6898						
10	6908	6882	6814	6729	6639	6592	6690	6687	6720	6781	6852	6896						
15	6829	6801	6715	6594	6459	6380	6496	6500	6565	6668	6779	6841						
20	6697	6669	6565	6409	6226	6112	6243	6254	6354	6501	6653	6734						
25	6509	6482	6362	6170	5937	5784	5931	5947	6082	6275	6471	6571						
30	6264	6239	6103	5874	5592	5401	5557	5578	5746	5987	6228	6349						
35	5957	5939	5787	5523	5190	4966	5129	5152	5350	5634	5922	6066						
40	5595	5580	5415	5116	4740	4483	4651	4675	4897	5221	5553	5722						
45	5178	5169	4990	4660	4246	3965	4131	4153	4393	4751	5124	5320						
50	4708	4706	4514	4159	3714	3416	3581	3600	3849	4233	4641	4865						
55	4197	4199	3999	3621	3158	2848	3012	3024	3276	3676	4113	4361						
60	3651	3657	3449	3058	2585	2273	2432	2437	2685	3091	3547	3818						
65	3080	3091	2876	2480	2009	1705	1856	1854	2090	2491	2959	3246						
70	2500	2512	2296	1902	1446	1159	1298	1287	1508	1894	2359	2659						
75	1920	1933	1719	1338	911	644	770	754	956	1315	1766	2070						
80	1351	1368	1161	807	419	181	285	268	443	770	1194	1490						
85	814	831	640	326	48.3	20.6	19.8	21.1	21.6	277	658	937						
90	322	338	178	20.3	22.2	23.5	22.5	23.9	22.7	21.0	176	428						
95	19.3	20.0	21.0	22.6	25.3	27.0	26.2	27.4	25.6	23.2	21.5	44.1						
100	21.8	22.4	23.6	25.8	28.7	30.7	30.0	31.1	28.9	26.2	23.8	22.6						
105	25.5	26.0	26.9	29.6	32.4	34.4	33.9	34.8	32.5	29.7	26.9	25.9						
110	30.6	30.9	31.6	34.2	37.3	39.3	38.5	39.5	36.9	34.0	31.3	30.4						
115	36.4	36.5	37.1	39.5	43.0	45.0	43.6	44.7	42.0	38.6	36.1	35.4						
120	41.3	41.3	41.7	43.9	47.3	50.0	48.3	49.5	46.4	42.9	40.7	39.9						
125	45.7	45.6	46.0	47.4	50.8	54.7	51.8	53.1	49.2	45.7	44.1	43.2						
130	49.4	49.1	49.5	50.5	53.8	58.1	55.1	56.3	51.6	48.2	47.0	46.2						
135	52.3	52.1	52.2	53.0	56.0	60.2	57.6	58.4	53.8	50.6	49.5	49.0						
140	55.1	55.4	55.0	55.5	58.2	61.0	59.6	59.9	55.9	53.0	52.2	52.1						
145	57.9	58.3	58.0	58.0	60.5	62.5	61.9	60.0	58.3	55.5	55.0	55.1						
150	60.5	61.4	61.2	60.8	63.1	61.8	64.5	61.4	60.7	58.2	58.0	58.0						
155	63.4	64.8	64.5	63.9	65.4	63.7	67.2	61.9	63.4	61.3	61.1	61.2						
160	66.0	68.5	67.5	65.9	67.5	69.1	70.3	67.0	66.1	64.0	64.4	64.9						
165	69.0	72.1	69.8	67.6	69.2	71.5	73.9	71.9	68.7	66.2	67.1	68.7						
170	71.5	74.1	70.6	68.6	69.9	72.9	76.4	73.6	70.5	68.0	68.8	71.6						
175	71.4	71.3	67.5	66.1	66.8	70.2	74.0	72.1	68.9	66.9	67.4	70.6						
180	67.9	66.9	63.4	62.1	62.4	65.5	67.9	66.9	63.5	62.1	62.4	65.5						

C Range: 0 - 360DEG
C Interval: 30.0DEG
Test Speed: HIGH
Temperature:25.3DEG
Operators:H
Test Date:2025-07-24

γ Range: 0 - 180DEG
γ Interval: 1.0DEG
Test System:EVERFINE GO-2000B_V1 SYSTEM V2.0.404.7
Humidity:65.0%
Test Distance:4.430m [K=1.0000]
Remarks:



Casambi Smart Luminaire Operation Demo

<https://casambi.com>

<https://casambi.com/news/casambi-tutorial-videos/>

CASAMBI

Casambi
App overview



Energy Saving
Skyraft

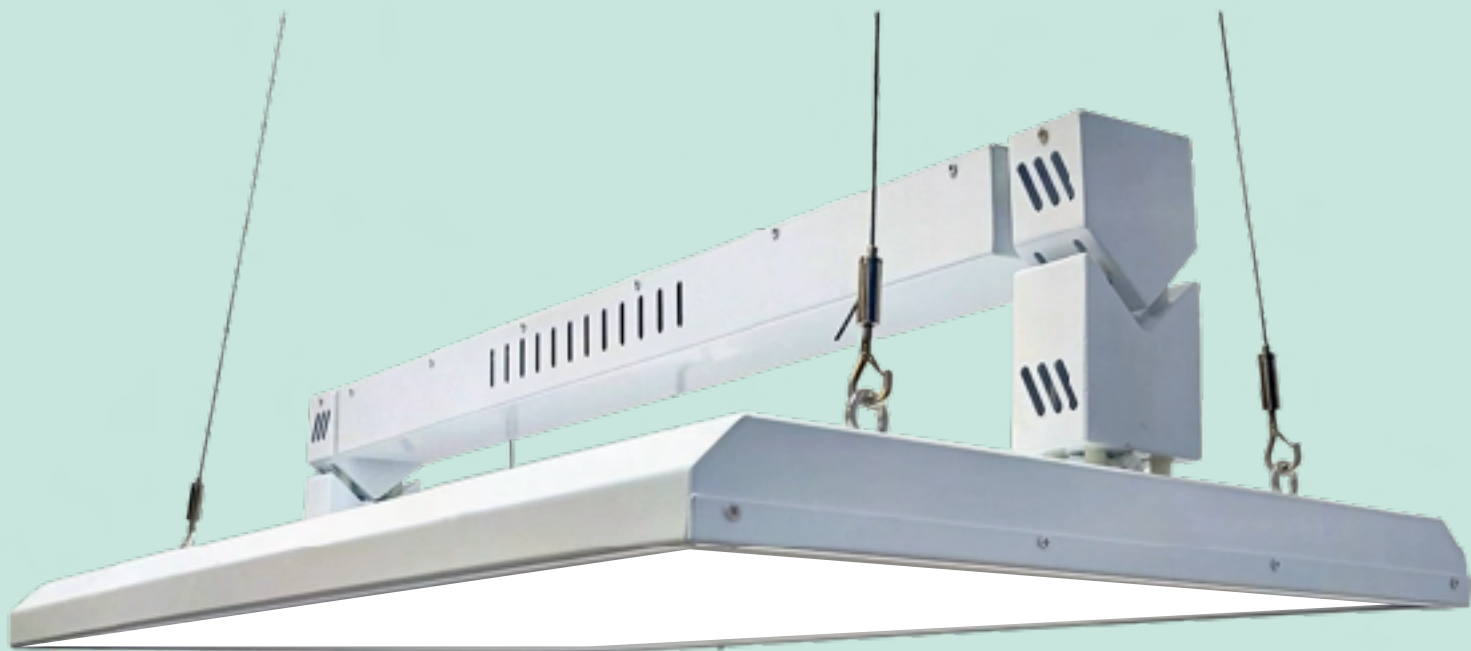

The best for the most with the least
Ray Eames

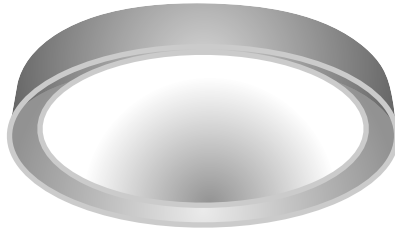

OPTIM•AL



Guarantee

Energy

Product Code

OPDREFE2400N34565UKEU
OPDREFE2400N34565MSUKEU
OPDREFE2400N34565EMUKEU
OPDREFE2400N34565EMMSUKEU

DREADNOUGHT Series

3 sizes, microsensor, dimmable, DALI, EM for airport, railway stations, sports stadiums, commercial and residential installations

Guarantee	10 years, insured with Lloyds of London
Energy Label	C
Lumens	3000-5000-8000
Watts	20, 30 or 50
CCT	3/4/5/6K switchable
CRI	80
Dimensions	30, 50, 80 cm diameter
Projection	50, 60, 80mm
Surface	Ceiling or Wall
Lens	Super tough convex Gorilla glass
Body	Die cast in 'thin wall' stainless steel 304
Certifications	UKCA, CE, TUV, VDE, RoHS, UL, CUL
IP/IK	IP 67, IK 10, EN 62262
Driver	Inventronic 10 year guarantee, dim, MS, EM version, 3 hour 20% output 3-year life. Li-ion batteries 1 for 30 cm, 2 for 50 cm and 3 for 80 cm diameter.
Design & Copyright	Studio FPM
Trademark	OPTIM•AL



OPTIM•AL



Guarantee

Energy

Product Code

OPDREFE2400N34565UKEU
 OPDREFE2400N34565MSUKEU
 OPDREFE2400N34565EMUKEU
 OPDREFE2400N34565EMMSUKEU

DREADNOUGHT BULKHEAD FULL **Diecast Aluminium body**

Guarantee	Insured 10 years; batteries 3 year rating/ 3 year performance
Body	Die cast in 'thin wall' stainless steel 304
Energy Label	E
Lumens	2400
Watts	Watts 20, lumens/watt 120
CCT	3/4/5/6K switchable
CRI	80
Dimensions	350mm dia x 107mm
Types	On-off; plus micro-wave sensor; or emergency 3 hour Lithium Ion batteries; battery life rating 3 years
Service Life	60000 hours
Certifications	TUV, CE, Rohs, SELV, UKCA, Recolight
Uses	Retail warehouse, industrial, exterior office, residential, general
IP/IK	IP65/IK10
Driver	PF 95
Design & Copyright	Studio FPM
Trademark	OPTIM•AL

OPTIM•AL



Guarantee

Energy

Product Code

OPDREHE240020N34565UKEU
OPDREHE240020N34565MSUKEU
OPDREHE240020N34565EMUKEU
OPDREHE240020N34565EMMSUKEU



DREADNOUGHT BULKHEAD HALF Diecast Aluminium body

Guarantee	Insured 10 years; batteries 3 year rating/ 3 year performance
Body	Die cast in 'thin wall' stainless steel 304
Energy Label	E
Lumens	2400
Watts	Watts 20, lumens/watt 120
CCT	3/4/5/6K switchable
CRI	80
Dimensions	350mm dia x 107mm
Types	On-off; plus micro-wave sensor; or emergency 3 hour Lithium Ion batteries; battery life rating 3 years
Service Life	60,000 Hours
Certifications	UKCA CE RoHS SELV Recolight
Uses	Retail warehouse, industrial, exterior office, residential, general
IP/IK	IP65/IK10
Driver	PF 95
Design & Copyright	Studio FPM
Trademark	OPTIM•AL

Energy Saving
Projector



OPTIM•AL



Guarantee



Energy

Product Code

OPPROTRACC24003N159003UKEU
OPPROTRACC24003N159004UKEU
OPPROTRACC24003N15POLUKEU

**FIXED BEAM
TRACK**

Powder painted aluminium or polished and natural anodized aluminium White RAL 9003 and Black RAL 9004

Guarantee	10 years warranted and insured by Lloyd's of London
Energy label	C
Lumens	2400, 160 lumens/watt
Watts	15 watts, 230 volts
CCT	3000K with 2-Step MacAdam
CRI	90
Beam angle	15 degrees, super optic lenses
Driver	Tridonic, PF 97 Non dimmable, 97-277v
Certificate	VDE, TUV, CE, Rohs, Recolight, NEMCO, UL, CUL, UKCA ISO 9001, ISO 14001, SEDEX, SMETA
Dimensions	180mm long, 90mm dia.
Service Life	60,000 hours /10 years
Uses	Retail, Museums, Showrooms
IP	54
Euro track	3 channels, 1 or 2 metres
Patented	UK/EU/USA convection cooling – Allom Cool Head Technology™
Design	Studio FPM
Trademark	OPTIM•AL

Energy Saving
Projector



OPTIM•AL



Guarantee

Energy

Product Code

OPPROTRACC24003N249003UKEU
OPPROTRACC24003N249004UKEU
OPPROTRACC24003N24POLUKEU

**FIXED BEAM
TRACK**

**Powder painted aluminium or polished and natural anodized
aluminium White RAL 9003 and Black RAL 9004**

Guarantee

10 years warranted and insured by Lloyd's of London

Energy label

C

Lumens

2400, 160 lumens/watt

Watts

15 watts, 230 volts

CCT

3000K with 2-Step MacAdam

CRI

90

Beam angle

24 degrees, super optic lenses

Driver

Tridonic, PF 97 Non dimmable, 97-277v

Certificate

VDE, TUV, CE, Rohs, Recolight, NEMCO, UL, CUL, UKCA
ISO 9001, ISO 14001, SEDEX, SMETA

Dimensions

180mm long, 90mm dia.

Service Life

60,000 hours /10 years

Uses

Retail, Museums, Showrooms

IP

54

Euro track

3 channels, 1 or 2 metres

Patented

UK/EU/USA convection cooling – Allom Cool Head Technology™

Design

Studio FPM

Trademark

OPTIM•AL

Energy Saving
Projector



OPTIM•AL



Guarantee

Energy

Product Code

OPPROTRACC24003N369003UKEU
OPPROTRACC24003N369004UKEU
OPPROTRACC24003N36POLUKEU

**FIXED BEAM
TRACK**

**Powder painted aluminium or polished and natural anodized
aluminium White RAL 9003 and Black RAL 9004**

Guarantee	10 years warranted and insured by Lloyd's of London
Energy label	C
Lumens	2400, 160 lumens/watt
Watts	15 watts, 230 volts
CCT	3000K with 2-Step MacAdam
CRI	90
Beam angle	36 degrees, super optic lenses
Driver	Tridonic, PF 97 Non dimmable, 97-277v
Certificate	VDE, TUV, CE, Rohs, Recolight, NEMCO, UL, CUL, UKCA ISO 9001, ISO 14001, SEDEX, SMETA
Dimensions	180mm long, 90mm dia.
Service Life	60,000 hours /10 years
Uses	Retail, Museums, Showrooms
IP	54
Euro track	3 channels, 1 or 2 metres
Patented	UK/EU/USA convection cooling – Allom Cool Head Technology™
Design	Studio FPM
Trademark	OPTIM•AL

Energy Saving
Projector



OPTIM•AL



Guarantee

Energy

Product Code

OPPPROCCL24003N159003UKEU
OPPPROCCL24003N159004UKEU
OPPPROCCL24003N15POLUKEU

**FIXED BEAM
CEILING PLATE**

Powder painted aluminium or polished and natural anodized aluminium White RAL 9003 and Black RAL 9004

Guarantee	10 years warranted and insured by Lloyd's of London
Energy label	C
Lumens	2400, 160 lumens/watt
Watts	15 watts, 230 volts
CCT	3000K with 2-Step MacAdam
CRI	90
Beam angle	15 degrees, super optic lenses
Driver	Tridonic, PF 97 Non dimmable, 97-277v
Certificate	VDE, TUV, CE, Rohs, Recolight, NEMCO, UL, CUL, UKCA ISO 9001, ISO 14001, SEDEX, SMETA
Dimensions	180mm long, 90mm dia. Ceiling plate 120mm dia., with rapid 3 pole connector Cut out 100mm dia.
Service Life	60,000 hours /10 years
Uses	Retail, Museums, Showrooms
IP	54
Patented	UK/EU/USA convection cooling – Allom Cool Head Technology™
Design	Studio FPM
Trademark	OPTIM•AL

Energy Saving
Projector



OPTIM•AL



Guarantee

Energy

Product Code

OPPPROCCL24003N249003UKEU
OPPPROCCL24003N249004UKEU
OPPPROCCL24003N24POLUKEU

**FIXED BEAM
CEILING PLATE**

Powder painted aluminium or polished and natural anodized aluminium White RAL 9003 and Black RAL 9004

Guarantee

10 years warranted and insured by Lloyd's of London

Energy label

C

Lumens

2400, 160 lumens/watt

Watts

15 watts, 230 volts

CCT

3000K with 2-Step MacAdam

CRI

90

Beam angle

24 degrees, super optic lenses

Driver

Tridonic, PF 97 Non dimmable, 97-277v

Certificate

VDE, TUV, CE, Rohs, Recolight, NEMCO, UL, CUL, UKCA
ISO 9001, ISO 14001, SEDEX, SMETA

Dimensions

180mm long, 90mm dia.
Ceiling plate 120mm dia., with rapid 3 pole connector
Cut out 100mm dia.

Service Life

60000 hours /10 years

Uses

Retail, Museums, Showrooms

IP

54

Patented

UK/EU/USA convection cooling – Allom Cool Head Technology™

Design

Studio FPM

Trademark

OPTIM•AL

Energy Saving
Projector



OPTIM•AL



Guarantee

Energy

Product Code

OPPPROCCL24003N369003UKEU
OPPPROCCL24003N369004UKEU
OPPPROCCL24003N36POLUKEU

**FIXED BEAM
CEILING PLATE**

Powder painted aluminium or polished and natural anodized aluminium White RAL 9003 and Black RAL 9004

Guarantee

10 years warranted and insured by Lloyd's of London

Energy label

C

Lumens

2400, 160 lumens/watt

Watts

15 watts, 230 volts

CCT

3000K with 2-Step MacAdam

CRI

90

Beam angle

36 degrees, super optic lenses

Driver

Tridonic, PF 97 Non dimmable, 97-277v

Certificate

VDE, TUV, CE, Rohs, Recolight, NEMCO, UL, CUL, UKCA
ISO 9001, ISO 14001, SEDEX, SMETA

Dimensions

180mm long, 90mm dia.
Ceiling plate 120mm dia., with rapid 3 pole connector
Cut out 100mm dia.

Service Life

60000 hours /10 years

Uses

Retail, Museums, Showrooms

IP

54

Patented

UK/EU/USA convection cooling – Allom Cool Head Technology™

Design

Studio FPM

Trademark

OPTIM•AL



Photography: Elizabeth Brown

Photographed at Woolsthorpe Manor, the birthplace of Sir Isaac Newton with the actual tree in the background courtesy of the National Trust.

Isaac Newton (1643 - 1727)



Newton was an English physicist and mathematician and the greatest scientist of his era.

Isaac Newton was born on 4 January 1643 at Woolsthorpe Manor, Lincolnshire. In 1661, he went to Cambridge University where he became interested in mathematics, optics, physics and astronomy. In October 1665 a plague epidemic forced the university to close and Newton returned to Woolsthorpe Manor. The two years he spent there were an extremely productive time during which he began to think about gravity, and also devoted time to optics and mathematics.

In 1667 Newton returned to Cambridge, where he became a Fellow of Trinity College. It was Newton's reflecting telescope, made in 1668, that finally brought him to the attention of the scientific community and in 1672 he was made a Fellow of the Royal Society. From the mid 1660's Newton conducted a series of experiments on the composition of light, discovering that white light is composed of the same system of colours that can be seen in a rainbow and establishing the modern study of optics. In 1704 Newton published 'The Opticks' which dealt with light and colour.

However, in 1687, with the help of the astronomer Edmond Halley, Newton published his single greatest work, the 'Philosophiae Naturalis Principia Mathematica' ('Mathematical Principles of Natural Philosophy'). This showed how a universal force, gravity, applied to all objects in all parts of the universe.

In 1703 he was elected President of the Royal Society, an office he held until his death. He died on 31 March 1727 and was buried in Westminster Abbey. He was 84 years old.



Newton

OPTIM•AL



Guarantee

Energy

Product Code

OPNEWT804B11103D60UKEU

NEWTON

804

Guarantee	10 years warranted and insured by Lloyd's of London
Energy Label	C
Watts	8 Watts
Lumens	1280
Lumens per Watt	160
CCT	3000K
CRI	90
Dimensions	Arms both 360mm
Service Life	60,000 hours
Beam Angle	7 x (2 x 30°) TIR reflectors (60°) super reflective
Dimmable	Dimmable
Driver	10 Watt Universal Driver 97-277v dimmable
Materials	Hand polished top grade Australian aircraft aluminium head clear lacquered and base plated, arms anodised
Certifications	UKCA, UL, CE, VDE and TUV
Patented	UK, EU, USA.
Design	Giancarlo Fassina and Carlo Forcolini, Studio FPM patented head with convection cooling UK, EU, USA
Trademark	OPTIM•AL

Newton

OPTIM•AL



10
Year



Guarantee

Energy

Product Code

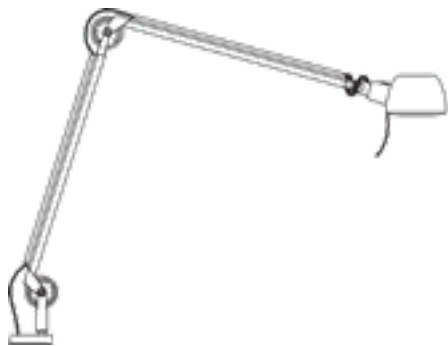

804 36 in
mini desk top
£ 355
OPNEWT804IN36B11103D60UKEU

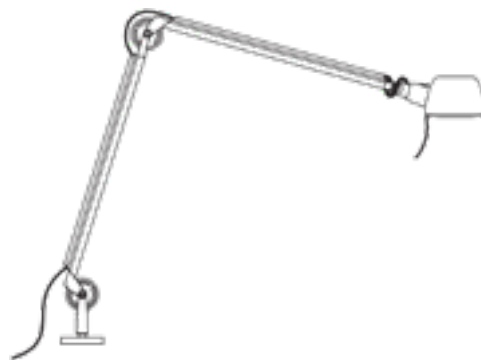

804 36 out
mini desk top
£ 355
OPNEWT804OUT36B11103D60UKEU



805 46 in
desk top
£ 375
OPNEWT805IN46B11103D60UKEU

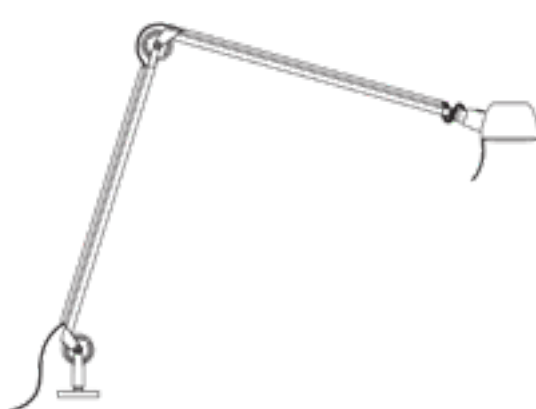

805 46 out
desk top
£ 375
OPNEWT805OUT46B11103D60UKEU

Newton

OPTIM•AL



10
Year



Guarantee

Energy

Product Code

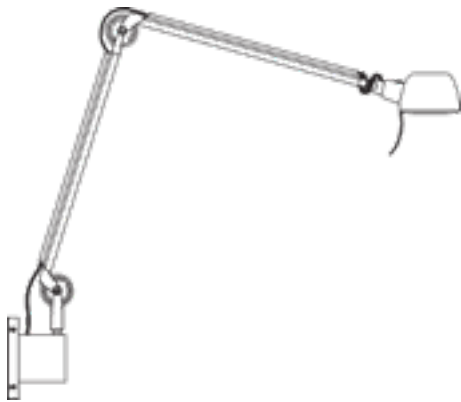

803 36 in
wall two arm
£ 365
OPNEWT803IN36B11103D60UKEU

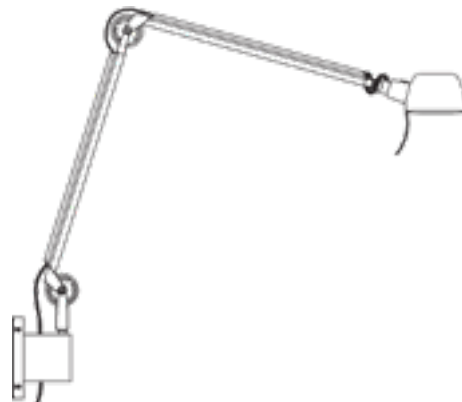

803 36 out
wall two arm
£ 365
OPNEWT803OUT36B11103D60UKEU

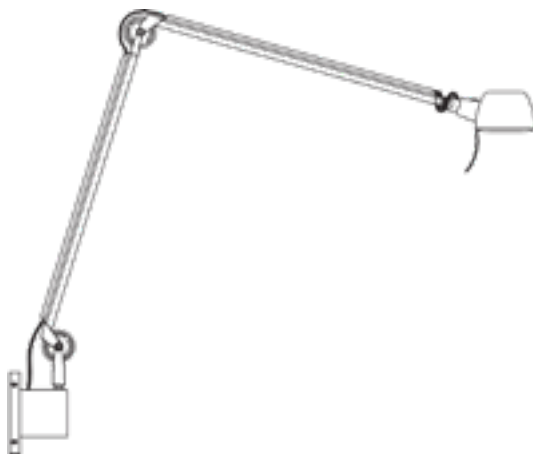

803 46 in
wall two arm
£ 395
OPNEWT803IN46B11103D60UKEU

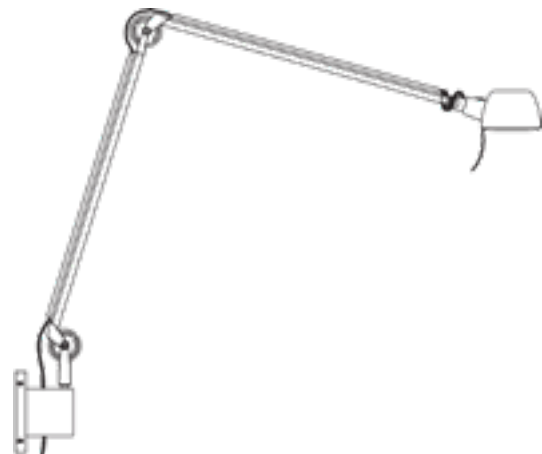

803 46 out
wall two arm
£ 395
OPNEWT803OUT46B11103D60UKEU

Newton

OPTIM•AL



Guarantee

Energy

Product Code

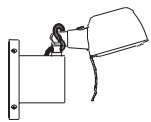

800 in
wall
£ 295
OPNEWT800INB11103D60UKEU

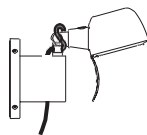

800 out
wall
£ 295
OPNEWT800OUTB11103D60UKEU

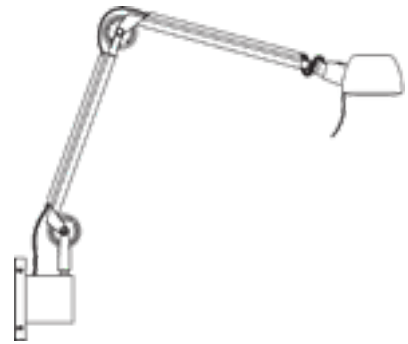

802 25 in
two arm
£ 345
OPNEWT802INB11103D60UKEU

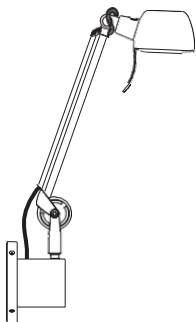

801 in
wall one arm
£ 325
OPNEWT801INB11103D60UKEU

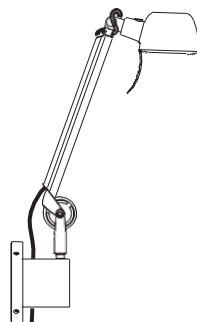

801 out
wall one arm
£ 325
OPNEWT801OUTB11103D60UKEU

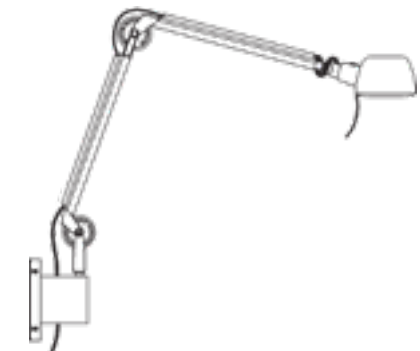

802 25 out
wall two arm
£ 345
OPNEWT802OUTB11103D60UKEU

Newton

OPTIM•AL



Guarantee

Energy

Product Code

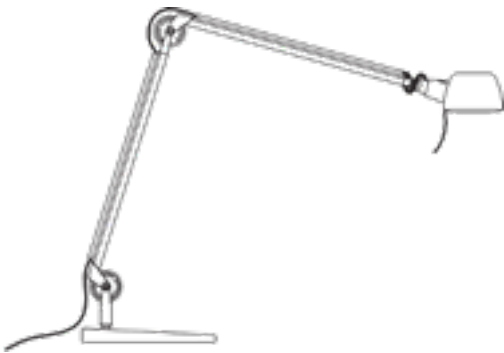

804 36

Mini table

£ 395

OPNEWT804B11103D60UK

OPNEWT804B11103D60EU



805 46

Table

£ 425

OPNEWT805B11103D60UK

OPNEWT805B11103D60EU



806 100 46

Floor

£ 495

OPNEWT806B11103D60UK

OPNEWT806B11103D60EU

EVCP.



Electrical Vehicle Charging Point

- 2 x 22kw, 2 x 55kw and 2 x 110kw AC 3 phase twin sockets and card readers
- RFID card/fob via OCCP management systems
- IP67 all weathers
- IK10 very robust structure with black nylon dampening seals and black nylon ribbon strips to all edges to dampen vibration
- 8 year guarantee, insured and certificated by Lloyds of London
- BSI tested and certificated, UKAL, CE, VDE, TUV, (UL and CUL later if required)
- 1300mm high x 420mm wide and 270mm deep
- Two Stainless Steel 304 pressed top and ribbed base plates 3mm thick to connect to the NAL inground
- Stainless Steel 304 body with many cutouts and welds for NAL fixing with 2 x M10 hexagon head bolts meter, 1 x twin card reader and 2x Mennekes charging sockets.
- Access panel covers 650mm high and 300mm wide to cover hole 600mm high and 250mm wide with black nylon ribbon 1mm thick all round inside of panel cover, secured with 8 x M8 stainless steel 304 bolts coated in black oxide & TORX security socket heads.
- E/driver Pay-to-charge smartphone integration
- Built in AC overload protection
- On board RFID readers and GPRS modem with antenna and ethernet connections
- OCCP-6 compliant, can integrate with any back office and remote firmware updates
- Type 2 (IEC 62196) 3 phase sockets c/w security hatchlocks
- Smart App/RFID controlled Mode 3 (IEC 61851-1) fast charging
- Painted with titanium epoxy powder RAL 9004, other colours by arrangement, on top of silicon dioxide
- Total of 52 TORX socket head M8 bolts, complete assembly with free issue TORX head wrenches

Charging Socket(s): 2 x IEC 62196-2 (Type 2) with illumination

Rated system output:

- 3.6 kW (16A), 7.2 kW (32A), and 22 kW
- Standby power consumption < 7w per socket

Input Voltage: 400V AC/50Hz (Single phase)

Overload & Fault Current Protection:

- Built in AC overload & Fault current protection (RCBO)
- Built in 6mA DC leakage protection
- Lightning surge protection
- TruePEN PME fault detection
- Support for dynamic load balancing & static load management
- Over-air software update/monitoring,
- Over temperature protection.

Street Connection: 5 x 50mm 3P + N + E

Energy Monitoring:

- Built in class 1 MID compliant kWh meter,
- Built in time clock for charge time management.

Charging Mode: IEC 61851-1 Mode 3

User interfacing:

- Plug and Charge Mobile App & RFID controlled
- Contactless payment systems interface
- Integrated RFID & GUI system panel

Communications:

- 4G LTE Cat-1
- Wi-Fi
- Ethernet connectivity
- Bluetooth BLE 4.1
- Encryption level TLS 1.2
- Open source card readers

Compliance:

OCCP compliant

BS 7671:2018 - SECTION 722 compliant.

Products - All with 10 year guarantee

Series S		Series 30	
S	Wall and ceiling light	31	Wall and ceiling light
FS	Single floor light	31T	Tronic wall and ceiling light
FS2	Twin floor light	31/50	Ceiling light
SS	Wall and ceiling light	31/2x50	Twin ceiling light
FSS	Single floor light	33/50	Single footlight
FSS2	Twin floor light	33/2x50	Twin footlight
Series A		Series 40	
A	Wall and ceiling light	41	Wall and ceiling light
A/SW	Switched wall light	41/2	Twin ceiling light
TA	Table light	41/4/1m	Four lamp ceiling light
FA	Single floor light	41/6/1.5m	Six lamp ceiling light
FA2	Twin floor light		
Series 20		Series 200	
21	Wall and ceiling light	201	Wall and ceiling light
21T	Tronic wall and ceiling light	201/SW	Switched wall light
21/50	Single ceiling light	201/2	Twin ceiling light
21/2x50	Twin ceiling light	201/3	Triple ceiling light
23/50	Single footlight	201/4	Four lamp ceiling light
23/2x50	Twin footlight	201/6/1.5m	Six lamp ceiling light
25/50	Table light	205	Table light
26/50	Floor light	206	Floor light
Downlights		GU10	
Downlight	IP20 Ceiling light	GU10	5 or 7 watt, dim or non dim
Downlight	IP65 Bathroom light	GU10	8.5, 1110 lumen, 63mm diameter

Series S

AL



S	Ceiling or wall light made from aircraft grade hand polished anodised aluminium
Guarantee	10 years warranted and insured by Lloyd's of London
Energy label	F
Lumens	1275
Watts	15
Lumen/Watts	85
Dimensions	150mm projection
Weight	305 grams
Lamp	R95 LED
CCT	3000K
CRI	80
Beam angle	120 degrees
Certificate	UKCA, CE, RoHS, Recolight
Trade mark	AL
Design	Peter Nelson

Series S

AL



FS	Single floor light
Guarantee	10 years warranted and insured by Lloyd's of London
Energy label	F
Lumens	1275
Watts	15
Lumen/Watts	85
Dimensions	1390mm height
Weight	3700 grams
Lamp	R95 LED
CCT	3000K
CRI	80
Beam angle	120 degrees
Certificate	UKCA, CE, RoHS, Recolight
Trade mark	AL
Design	Peter Nelson

Series S

AL



FS2	Twin floor light
Guarantee	10 years warranted and insured by Lloyd's of London
Energy label	F
Lumens	1275
Watts	15
Lumen/Watts	85
Dimensions	1390mm height
Weight	3950 grams
Lamp	R95 LED
CCT	3000K
CRI	80
Beam angle	120 degrees
Certificate	UKCA, CE, RoHS, Recolight
Trade mark	AL
Design	Peter Nelson



A	Ceiling light
Guarantee	10 years warranted and insured by Lloyd's of London
Energy label	F
Lumens	1275
Watts	15
Lumen/Watts	85
Dimensions	150mm projection
Weight	360 grams
Lamp	R95, LED, E27
Beam angle	35 degrees
Certificate	UKCA, CE, RoHS, Recolight
Trade mark	AL
Design	Peter Nelson



A/SW	Wall light
Guarantee	10 years warranted and insured by Lloyd's of London
Energy label	F
Lumens	1275
Watts	15
Lumen/Watts	85
Dimensions	150mm projection
Weight	360 grams
Lamp	R95, LED, E27
Beam angle	35 degrees
Certificate	UKCA, CE, RoHS, Recolight
Trade mark	AL
Design	Peter Nelson

Series A

AL



TA	Table lamp
Guarantee	10 years warranted and insured by Lloyd's of London
Energy label	F
Lumens	1275
Watts	15
Lumen/Watts	85
Dimensions	550mm height
Weight	1850 grams
Lamp	R95, LED, E27
Beam angle	120 degrees
Certificate	UKCA, CE, RoHS, Recolight
Trade mark	AL
Design	Peter Nelson

Series A

AL



FA	Single floor light
Guarantee	10 years warranted and insured by Lloyd's of London
Energy label	F
Lumens	1275
Watts	15
Lumen/Watts	85
Dimensions	1390mm height
Weight	3850 grams
Lamp	R95, LED, E27
Beam angle	120 degrees
Certificate	UKCA, CE, RoHS, Recolight
Trade mark	AL
Design	Peter Nelson

Series A

AL



FA2	Twin floor light
Guarantee	10 years warranted and insured by Lloyd's of London
Energy label	F
Lumens	1275
Watts	15
Lumen/Watts	85
Dimensions	1390mm height
Weight	4250 grams
Lamp	R95, LED x 2, E27
Beam angle	120 degrees
Certificate	UKCA, CE, RoHS, Recolight
Trade mark	AL
Design	Peter Nelson



21	Ceiling or wall light made from aircraft grade hand polished anodised aluminium
Guarantee	10 years warranted and insured by Lloyd's of London
Energy label	G
Lumens	690
Watts	9
Lumen/Watts	77
Dimensions	140mm projection
Weight	210 grams
Lamp	GU5.3 MR16 LED 12V
CCT	3000K
CRI	90
Beam angle	36 degrees
Certificate	UKCA, CE, RoHS, Recolight
Trade mark	AL
Design	Peter Nelson



21T **Ceiling or wall light made from aircraft grade hand polished anodised aluminium**

Guarantee	10 years warranted and insured by Lloyd's of London
Energy label	G
Lumens	690
Watts	9
Lumen/Watts	77
Dimensions	140mm projection
Weight	355 grams
Lamp	GU5.3 MR16 LED 12V
CCT	3000K
CRI	90
Beam angle	36 degrees
Certificate	UKCA, CE, RoHS, Recolight
Trade mark	AL
Design	Peter Nelson



21/50	Ceiling or wall light made from aircraft grade hand polished anodised aluminium
Guarantee	10 years warranted and insured by Lloyd's of London
Energy label	G
Lumens	690
Watts	9
Lumen/Watts	77
Dimensions	180mm projection
Weight	900 grams
Lamp	GU5.3 MR16 LED 12V
CCT	3000K
CRI	90
Beam angle	36 degrees
Certificate	UKCA, CE, RoHS, Recolight
Trade mark	AL
Design	Peter Nelson

Series 20

AL



21 2x 50	Ceiling or wall light made from aircraft grade hand polished anodised aluminium
Guarantee	10 years warranted and insured by Lloyd's of London
Energy label	G
Lumens	690
Watts	9
Lumen/Watts	77
Dimensions	220mm projection
Weight	1613 grams
Lamp	GU5.3 MR16 LED 12V
CCT	3000K
CRI	90
Beam angle	36 degrees
Certificate	UKCA, CE, RoHS, Recolight
Trade mark	AL
Design	Peter Nelson



23/50	Single footlight
Guarantee	10 years warranted and insured by Lloyd's of London
Energy label	G
Lumens	690
Watts	9
Lumen/Watts	77
Dimensions	180mm height
Weight	1226 grams
Lamp	GU 5.3
CCT	3000k
CRI	90
Beam angle	36 degrees
Certificate	UKCA, CE, RoHS, Recolight
Trade mark	AL
Design	Peter Nelson

Series 20

AL



23/2x50	Double footlight
Guarantee	10 years warranted and insured by Lloyd's of London
Energy label	G
Lumens	690
Watts	9
Lumen/Watts	77
Dimensions	220mm height
Weight	1900 grams
Lamp	GU5.3 MR16 LED 12V
CCT	3000k
CRI	90
Beam angle	36 degrees
Certificate	UKCA, CE, RoHS, Recolight
Trade mark	AL
Design	Peter Nelson

Series 20

AL

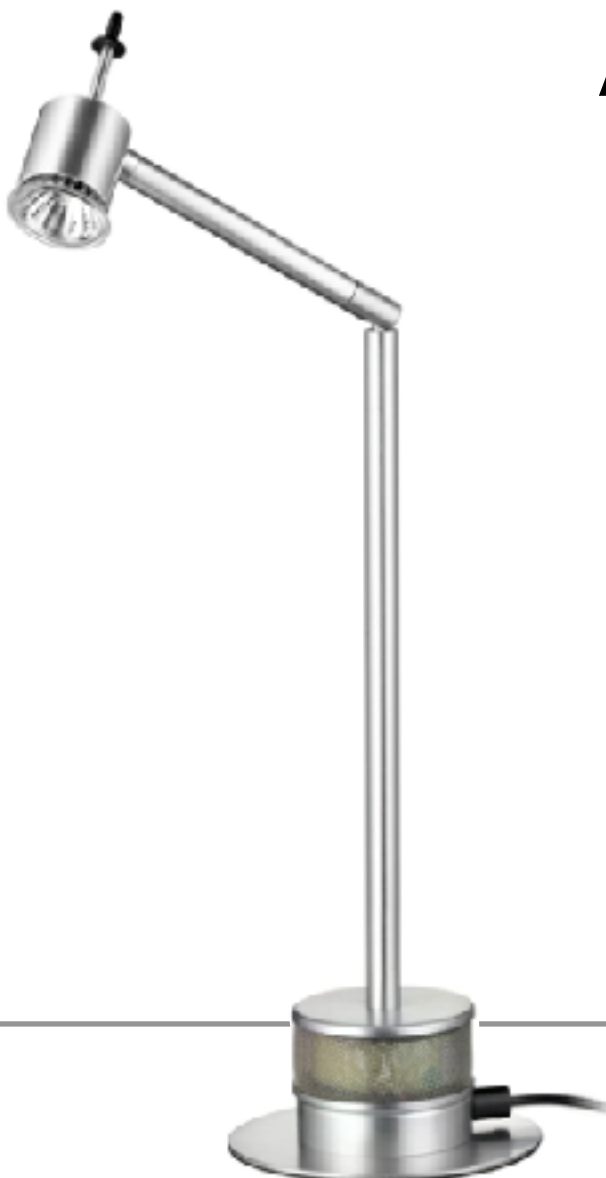

25/50

Table light

Guarantee	10 years warranted and insured by Lloyd's of London
Energy label	G
Lumens	690
Watts	9
Lumen/Watts	77
Dimensions	575mm height
Weight	1400 grams
Lamp	GU 5.3MR16 LED 12V
CCT	3000k
CRI	90
Beam angle	36 degrees
Certificate	UKCA, CE, RoHS, Recolight
Trade mark	AL
Design	Peter Nelson

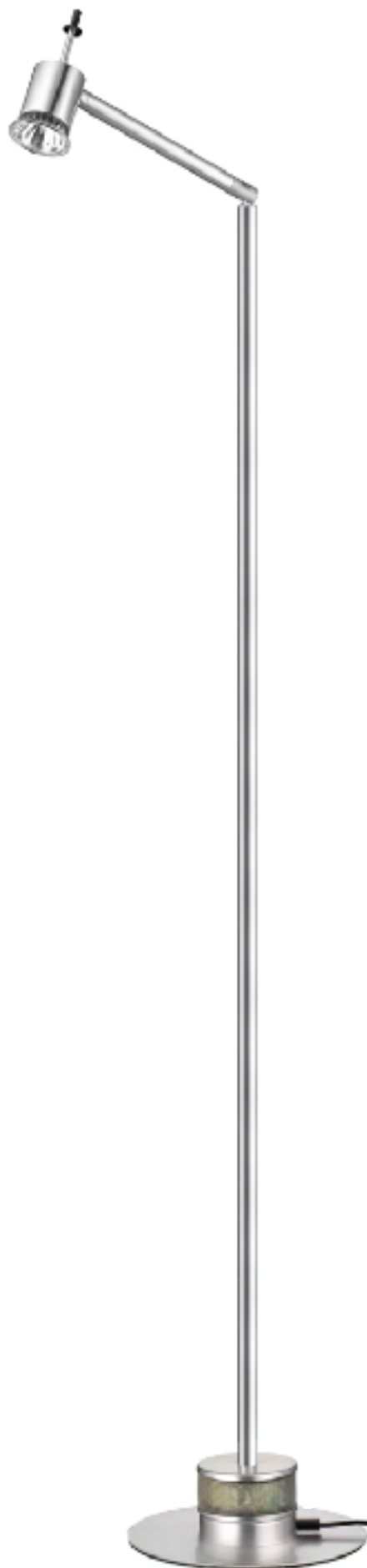

26/50	Floor light
Guarantee	10 years warranted and insured by Lloyd's of London
Energy label	G
Lumens	690
Watts	9
Lumen/Watts	77
Dimensions	1275mm height
Weight	1650 grams
Lamp	GU 5.3 MR16 LED 12V
CCT	3000k
CRI	90
Beam angle	36 degrees
Certificate	UKCA, CE, RoHS, Recolight
Trade mark	AL
Design	Peter Nelson



31 **Ceiling or wall light made from aircraft grade hand polished anodised aluminium**

Guarantee	10 years warranted and insured by Lloyd's of London
Energy label	G
Lumens	540
Watts	8
Lumen/Watts	73
Dimensions	130mm projection
Weight	230 grams
Lamp	B15d AR70 LED 12V reflector
CCT	3000k
CRI	90
Beam angle	25 degrees
Certificate	UKCA, CE, RoHS, Recolight
Trade mark	AL
Design	Peter Nelson



31T **Ceiling or wall light made from aircraft grade hand polished anodised aluminium**

Guarantee 10 years warranted and insured by Lloyd's of London

Energy label G

Lumens 540

Watts 8

Lumen/Watts 68

Dimensions 130mm projection

Weight 410 grams

Lamp B15d AR70 LED 12V reflector

CCT 3000k

CRI 90

Beam angle 25 degrees

Certificate UKCA, CE, RoHS, Recolight

Trade mark AL

Design Peter Nelson

Series 30

AL



31/50	Ceiling or wall light made from aircraft grade hand polished anodised aluminium
Guarantee	10 years warranted and insured by Lloyd's of London
Energy label	G
Lumens	540
Watts	8
Lumen/Watts	68
Dimensions	170mm projection
Weight	955 grams
Lamp	B15d AR70 LED 12V reflector
CCT	3000k
CRI	90
Beam angle	25 degrees
Certificate	UKCA, CE, RoHS, Recolight
Trade mark	AL
Design	Peter Nelson



31/2 x 50 **Ceiling or wall light made from aircraft grade hand polished anodised aluminium**

Guarantee 10 years warranted and insured by Lloyd's of London

Energy label G

Lumens 540

Watts 8

Lumen/Watts 68

Dimensions 220mm projection

Weight 1615 grams

Lamp B15d AR70 LED 12V reflector

CCT 3000k

CRI 90

Beam angle 24 degrees

Certificate UKCA, CE, RoHS, Recolight

Trade mark AL

Design Peter Nelson



41 **Ceiling or wall light made from aircraft grade hand polished anodised aluminium**

Guarantee 10 years warranted and insured by Lloyd's of London

Energy label G

Lumens 540

Watts 14-8

Lumen/Watts 60

Dimensions 100mm projection

Weight 220 grams

Lamp AR111 AR70 LED 12V reflector

CCT 3000k

CRI 90

Beam angle 24 degrees

Certificate UKCA, CE, RoHS, Recolight

Trade mark AL

Design Peter Nelson



41/2	Ceiling or wall light made from aircraft grade hand polished anodised aluminium
Guarantee	10 years warranted and insured by Lloyd's of London
Energy label	G
Lumens	888
Watts	14-8
Lumen/Watts	60
Dimensions	170mm width
Weight	445 grams
Lamp	AR111 AR70 LED 12V reflector
CCT	3000k
CRI	90
Beam angle	24 degrees
Certificate	UKCA, CE, RoHS, Recolight
Trade mark	AL
Design	Peter Nelson



41/4 Ceiling or wall light made from aircraft grade hand polished anodised aluminium

Guarantee 10 years warranted and insured by Lloyd's of London

Energy label G

Lumens 888

Watts 14-8

Lumen/Watts 60

Dimensions 1000mm width

Weight 1370 grams

Lamp B15d AR70 LED 12V reflector

CCT 3000k

CRI 90

Beam angle 24 degrees

Certificate UKCA, CE, RoHS, Recolight

Trade mark AL

Design Peter Nelson



41/6 **Ceiling or wall light made from aircraft grade hand polished anodised aluminium**

Guarantee 10 years warranted and insured by Lloyd's of London

Energy label G

Lumens 888

Watts 14-8

Lumen/Watts 60

Dimensions 1500mm width

Weight 2000 grams

Lamp B15d AR70 LED 12V reflector

CCT 3000k

CRI 90

Beam angle 24 degrees

Certificate UKCA, CE, RoHS, Recolight

Trade mark AL

Design Peter Nelson

Series 200

AL



201 **Wall and ceiling light made from aircraft grade hand polished anodised aluminium**

Guarantee 10 years warranted and insured by Lloyd's of London

Energy label G

Lumens 1110

Watts 8.5

Lumen/Watts 130

Dimensions 150mm projection

Weight 215 grams

Lamp GU10 63mm dia LED

CCT 3000k

CRI 90

Beam angle 38 degrees

Certificate UKCA, CE, RoHS, Recolight

Trade mark AL

Design Peter Nelson

Series 200

AL

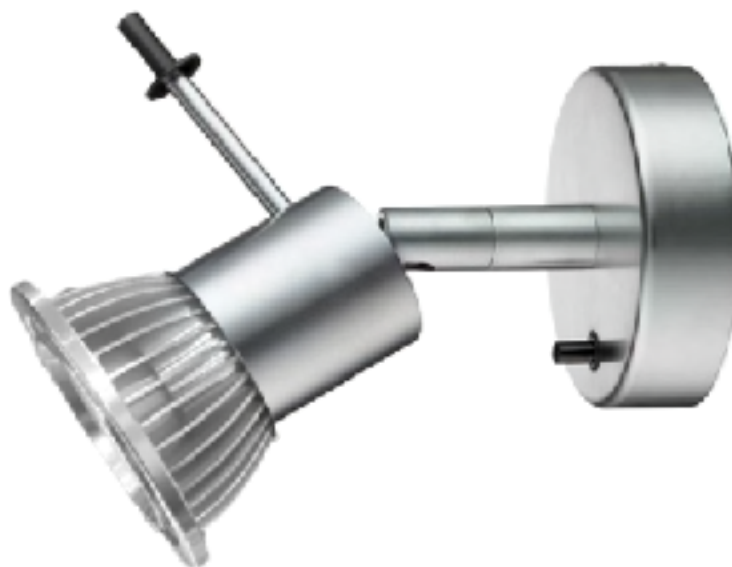

201/SW **Switched wall light made from aircraft grade hand polished anodised aluminium**

Guarantee 10 years warranted and insured by Lloyd's of London

Energy label G

Lumens 1110

Watts 8.5

Lumen/Watts 130

Dimensions 150mm projection

Weight 220 grams

Lamp GU10 63mm dia LED

CCT 3000k

CRI 90

Beam angle 38 degrees

Certificate UKCA, CE, RoHS, Recolight

Trade mark AL

Design Peter Nelson

Series 200

AL



201/2 **Twin ceiling light made from aircraft grade hand polished anodised aluminium**

Guarantee 10 years warranted and insured by Lloyd's of London

Energy label G

Lumens 1110

Watts 8.5

Lumen/Watts 130

Dimensions 170mm projection

Weight 435 grams

Lamp GU10 63mm dia LED

CCT 3000k

CRI 90

Beam angle 38 degrees

Certificate UKCA, CE, RoHS, Recolight

Trade mark AL

Design Peter Nelson



201/3 **Triple ceiling light made from aircraft grade hand polished anodised aluminium**

Guarantee 10 years warranted and insured by Lloyd's of London

Energy label G

Lumens 1110

Watts 8.5

Lumen/Watts 130

Dimensions 280mm width

Weight 620 grams

Lamp GU10 63mm dia LED

CCT 3000k

CRI 90

Beam angle 38 degrees

Certificate UKCA, CE, RoHS, Recolight

Trade mark AL

Design Peter Nelson



201/4 **Four spot ceiling light made from aircraft grade hand polished anodised aluminium**

Guarantee 10 years warranted and insured by Lloyd's of London

Energy label G

Lumens 1110

Watts 8.5

Lumen/Watts 130

Dimensions 1000mm width

Weight 1350 grams

Lamp GU10 63mm dia LED

CCT 3000k

CRI 90

Beam angle 38 degrees

Certificate UKCA, CE, RoHS, Recolight

Trade mark AL

Design Peter Nelson



201/6 **Six spot ceiling light made from aircraft grade hand polished anodised aluminium**

Guarantee 10 years warranted and insured by Lloyd's of London

Energy label G

Lumens 1110

Watts 8.5

Lumen/Watts 130

Dimensions 1500mm width

Weight 1970 grams

Lamp GU10 63mm dia LED

CCT 3000k

CRI 90

Beam angle 38 degrees

Certificate UKCA, CE, RoHS, Recolight

Trade mark AL

Design Peter Nelson

Series 200

AL



205 **Table light made from aircraft grade hand polished anodised aluminium**

Guarantee 10 years warranted and insured by Lloyd's of London

Energy label E

Lumens 1110

Watts 8.5

Lumen/Watts 130

Dimensions 690mm height

Weight 2180 grams

Lamp GU10 63mm dia LED

CCT 3000k

CRI 90

Beam angle 38 degrees

Certificate UKCA, CE, RoHS, Recolight

Trade mark AL

Design Peter Nelson

Series 200

AL

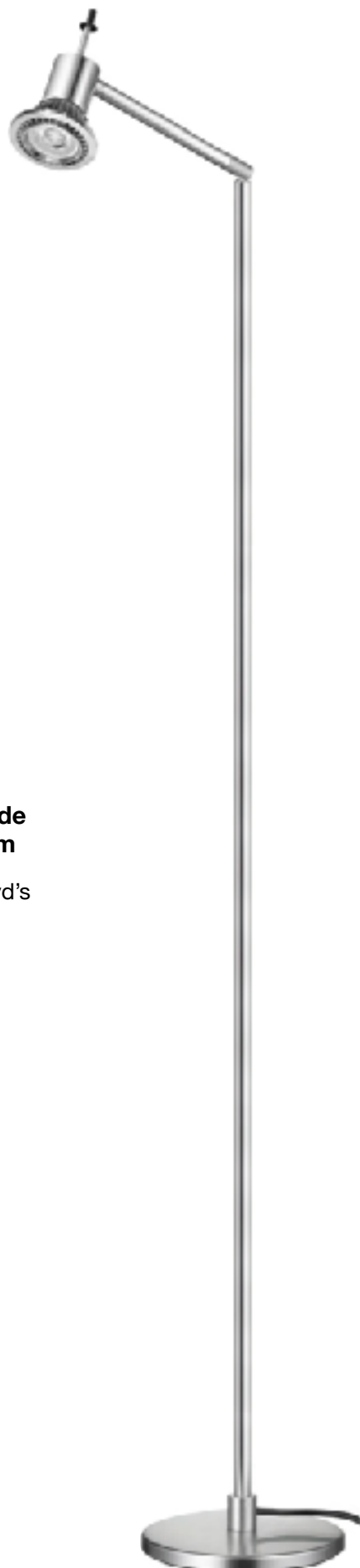

206 **Floor light made from aircraft grade hand polished anodised aluminium**

Guarantee	10 years warranted and insured by Lloyd's of London
Energy label	G
Lumens	1110
Watts	8.5
Lumen/Watts	130
Dimensions	1450mm height
Weight	3605 grams
Lamp	GU10 63mm dia LED
CCT	3000k
CRI	90
Beam angle	38 degrees
Certificate	UKCA, CE, RoHS, Recolight
Trade mark	AL
Design	Peter Nelson

Downlight



Downlight	Round white bathroom downlight
Guarantee	10 years warranted and insured by Lloyd's of London
Lumens	450 or 630
Watts	5 or 7 GU10 dim or non-dim
Dimensions	Dia. 85mm, Height 73mm
Cut out	75mm
Certificate	UKCA, CE, RoHS, Recolight
Trade mark	AL
Glass	Clear or Opal
IP	65, Bathroom

Downlight

AL

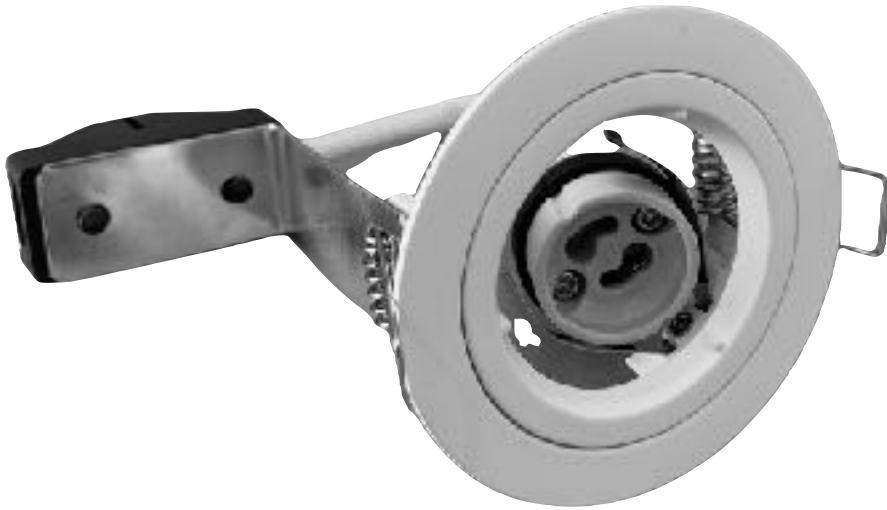

Downlight	Fixed downlight - white
Guarantee	10 years warranted and insured by Lloyd's of London
Dimensions	Dia. 80mm, Silicon 15cm cable, metal strip: Terminal block and GU10 holder
Cut out	70mm
Certificate	UKCA, CE, RoHS, Recolight
Trade mark	AL
IP	20, general use

GU10

AL



GU10	Dim or non-dim
Guarantee	10 years warranted and insured by Lloyd's of London
Lumens	450 or 630
Energy label	F
Watts	5 or 7
CCT	3000K
CRI	80
Dimensions	Dia. 50mm, Height 55.5mm
Service Life	50,000 hours
Beam angle	38 degrees
Dimmable	Non dim or dimmable use Varilight V-Pro 300watt
Certificate	UKCA, CE, RoHS, Recolight
Trade mark	AL

"that which is not worth doing,
is not worth doing well"

Warren Buffett

Allom

Architectural Lighting